

**Enjoy peace of mind.  
Register your appliance today.**

Stay updated on better living services, safety notices and shop for accessories.

- 1. Open the camera app on your smartphone and point at the QR code to scan**  
Product Registration QR code is located on the front of your appliance or inside the door rim\*.

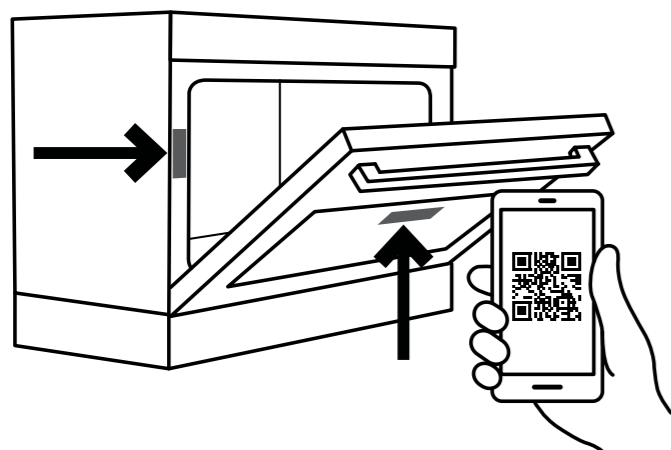

- 2. Tap the notification or link to open the registration form**
- 3. Complete your details and enjoy peace of mind**

\*Exact location of QR code may vary depending on oven model



**Need more help?**

To access your detailed user manual online, simply scan the QR code on your smart phone. If you prefer a printed manual, please contact our Customer Care Centre using details below.



**Contact us if you need more help**

**Electrolux Home Products Australia**

telephone: 13 13 49  
email: [customercare@electrolux.com.au](mailto:customercare@electrolux.com.au)  
web: [electrolux.com.au](http://electrolux.com.au)

**Electrolux Home Products New Zealand**

telephone: 0800 436 245  
email: [customercare@electrolux.co.nz](mailto:customercare@electrolux.co.nz)  
web: [electrolux.co.nz](http://electrolux.co.nz)

Dear Customer,

Thank you for purchasing a Westinghouse appliance. You have chosen a product that comes from a history of durable and reliable products loved by many families. We look to help you make the most of your time at home, so you can spend your time doing what you really love, with the ones you love.

Welcome to Westinghouse.

**Ready**



**This is a Quick Start Guide. Please refer to user manual online for detailed information and installation**

To access your detailed user manual online, simply scan the QR code on your smart phone.

For more detailed information and installation guide refer to user manuals at [westinghouse.com.au/manuals](http://westinghouse.com.au/manuals)

**Before you start, please make sure:**

- Your cooker has been correctly installed by a qualified person.
- Your cooker has power and is switched on.
- You've removed all relevant packaging.



Most of the packaging materials can be recycled. Please dispose of them at your local recycling centre or in your own recycling bin.

**Set...**

**Get to know the control panel:**

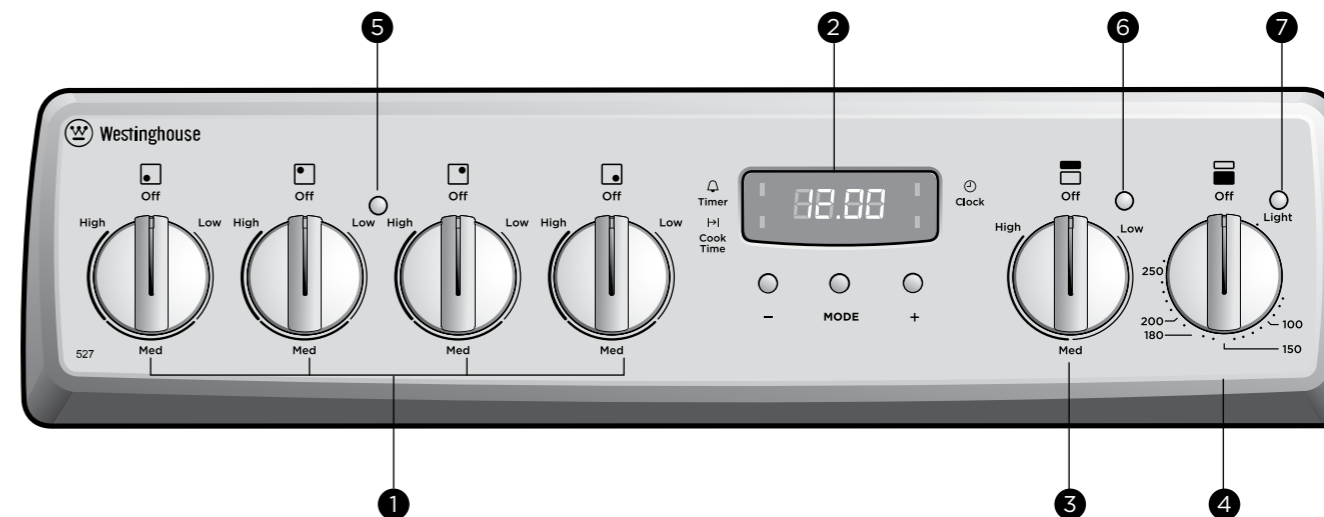

- |   |   |                                  |
|---|---|----------------------------------|
| <b>1</b> Ceramic cooktop temperature control knob | <b>3</b> Grill temperature control knob | <b>5</b> Cooktop indicator light |
| <b>2</b> Programmable clock                       | <b>4</b> Oven temperature control knob  | <b>6</b> Grill indicator light   |
|   |   | <b>7</b> Oven indicator light    |

# Set...

## Installing the accessories

### Fitting the oven shelves

1. Ensure shelf orientation is correct (refer to diagram below).
2. Slide oven shelves onto oven supports (side runners) at an angle until raised back of shelf is past the stop on oven supports (side runners).
3. Lower front of shelf and push in until stop is reached.
4. To remove oven shelves, withdraw to the stop and raise the front of shelf to clear the stop.

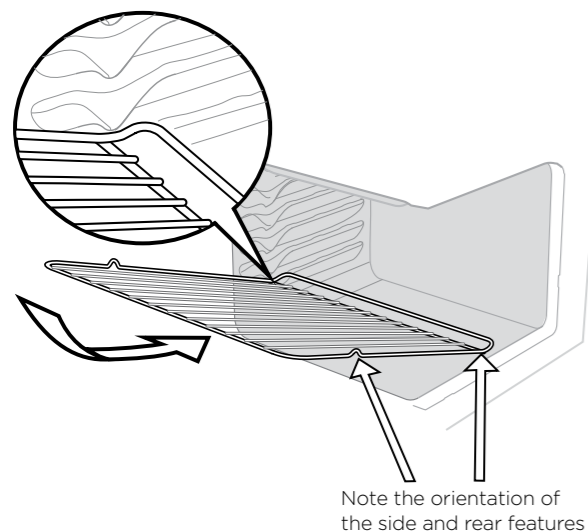

### Fitting the grill dish supports

1. Insert the rear hook into the rear hole.
2. Align the front peg to the front hole and push in firmly.

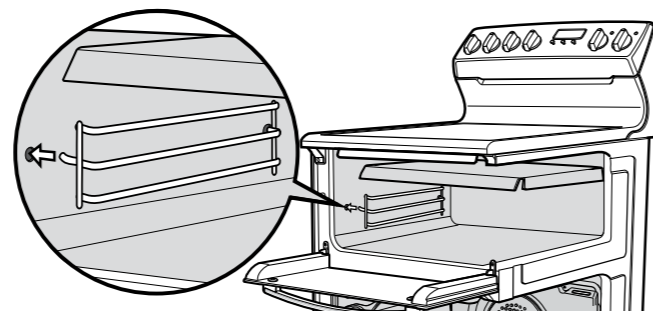

### Fitting the grill dish

Ensure rear of the dish is engaged with the side support before sliding backwards. To remove, simply pull forwards and upwards.

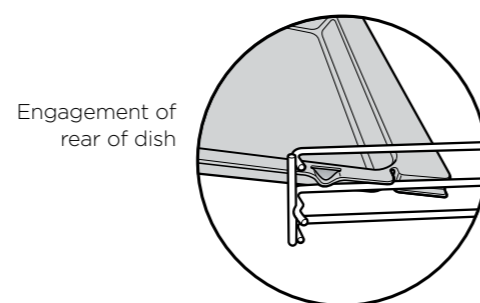

## Set the time

After electrically connecting the appliance, you must set the time of day before you can operate your oven.

- After the appliance has been electrically connected, "12:00" will be displayed and the clock ⌚ indicator will flash.
- To set the time of day in hours and minutes press the **-** or **+** buttons.
- 5 seconds after the last change, the clock ⌚ indicator will disappear, confirming the time has been set. Once the time has been entered, the clock advances minute by minute.

*Note: The clock has a 24 hour display.*

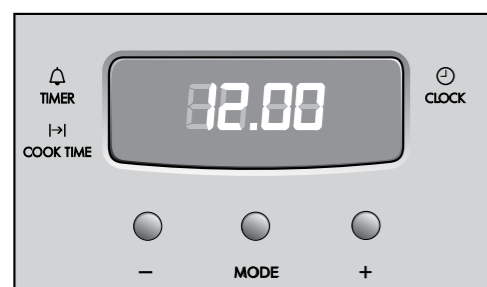

## Condition the oven

(to burn off any residue)

New appliances can have oil or residue left from manufacturing. You will need to heat your oven for 30 minutes before using it for the first time.

1. Using the oven control knob, set the oven at 180°C for approximately 30 minutes. Later, run the grill on maximum for 15 minutes with grill door open.

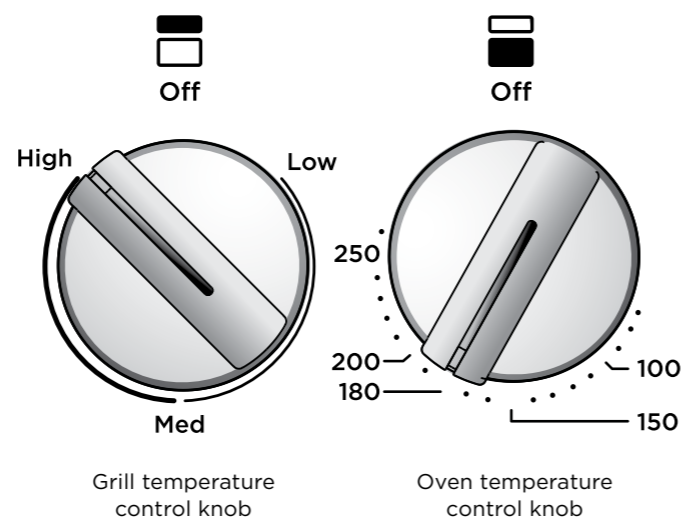

# Go!

## You're ready to use your new Westinghouse appliance. A few tips from us:

- Remember to pre-heat each time.**

For best cooking results pre-heat the oven. Pre-heating allows the oven to reach the required temperature quickly and efficiently as well as cook food at the correct temperature for the entire cook time. Recommended pre-heat time is 30 mins for baking and 3 minutes for grilling.

- Choose the right program for the best result:**

### CERAMIC COOKTOP

Our range of ceramic cooktops combine stylish good looks with practical features to help you prepare delicious meals with ease and confidence.

While the durable ceramic surface is tough enough to handle the everyday knocks of the busiest family kitchen, it must be remembered that the surface is made of glass and should not be treated as unbreakable.

### OVEN

In a fan forced electric oven the heat comes from the rear oven element. Hot air is distributed by a fan behind the rear wall of the compartment, providing an even temperature on all shelf levels - perfect for multi-level cooking or reheating entire meals for your family.

### GRILL

When it comes to cooking tender cuts of meat, steak, chops, sausages, fish, cheese toasties and other quick cooking foods, the grill setting will give you the best results. Pre-heating your grill for 3 minutes will help in sealing in the natural juices of the food for better flavour. For separate grill models, grill with the grill door open.

Refer to your full user manual for more details on oven functions.

- Set your temperature**

- To set the temperature, turn the grill/oven knob in a clockwise direction to the desired setting.
- An indicator light in the display will turn on and the grill/oven will begin to heat.
- Once the food is cooked, turn the temperature selector back in an anti-clockwise direction.

*Note: The oven indicator light cycles on and off when the temperature is reached.*