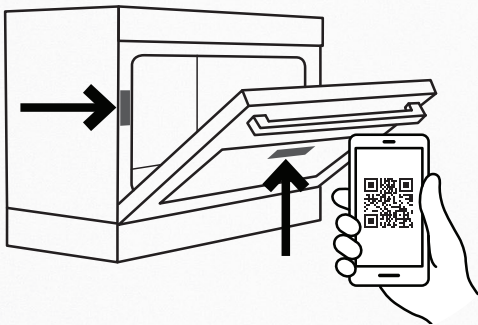

**Enjoy peace of mind.
Register your appliance today.**

Stay updated on better living services, safety notices and shop for accessories.

1. Open the camera app on your smartphone and point at the QR code to scan

Product Registration QR code is located on the front of your appliance or inside the door rim*.

**2. Tap the notification or link to open the registration form****3. Complete your details and enjoy peace of mind**

*Exact location of QR code may vary depending on oven model

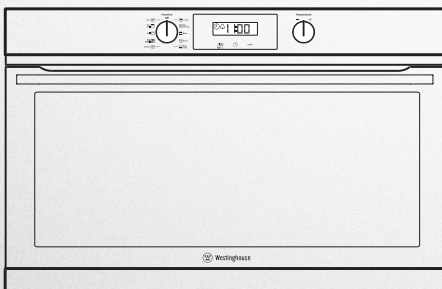
**90cm ELECTRIC
BUILT-IN OVENS**

WVE915SC, WVE915SCA, WVE915DSCA,
WVEP916SC, WVEP917DSC

CONGRATULATIONS

Congratulations and thank you for choosing our product.

We are sure you will find your new cooker a pleasure to use and a great asset to your cooking. Before you use the appliance, we recommend you read through the whole user manual which provides a description of the product and its functions.

To avoid the risks that are always present when you use an appliance, it is important that the appliance is installed correctly and that you read the safety instructions carefully to avoid misuse and hazards. We recommend that you keep this instruction booklet for future reference and pass it on to any future owners.

This appliance complies with the requirements of Australian Standard AS/NZS 60335.2.6.

Conditions of use

This appliance is intended to be used in household and similar applications such as:

- Staff kitchen areas in shops, offices and other working environments
- Farm houses
- By clients in hotels, motels and other residential type environments
- Bed and breakfast type environments

Please ensure you read the instruction manual fully before you call for service, or a full service fee could be applicable.

Record model and serial number here:

Model number:.....

Serial number:.....

PNC:.....

IMPORTANT INFORMATION THAT MAY IMPACT YOUR MANUFACTURER'S WARRANTY

Adherence to the directions for use in this manual is extremely important for health and safety. Failure to strictly adhere to the requirements in this manual may result in personal injury, property damage and affect your ability to make a claim under the Westinghouse manufacturer's warranty provided with your product. Products must be used, installed and operated in accordance with this manual. You may not be able to claim on the Westinghouse manufacturer's warranty in the event that your product fault is due to failure to adhere to this manual.

CONTENTS

Important safety instructions.....	3
Description of your appliance:	
WVE915SC	5
WVE915SCA, WVE915DSCA	5
WVEP916SC, WVEP917DSC	6
Installation of the appliance.....	7
Wiring requirements.....	10
Before operating your appliance for the first time.....	11
Installing your oven accessories	12
Using your oven.....	14
Operating WVE915SC	17
Operating WVEP916SC.....	19
Operating WVE915SCA, WVE915DSCA and WVEP917DSC	22
Cooking test	28
Cooking guide	28
Dealing with cooking problems	32
Cleaning your oven	33
Cleaning your pyrolytic oven	35
Troubleshooting.....	37
Notes.....	38
Warranty.....	39

Please read this user manual carefully and store in a handy place for later reference.

The symbols you will see in this booklet have the following meanings:



WARNING

This symbol indicates information concerning your personal safety.



CAUTION

This symbol indicates information on how to avoid damaging the appliance.



IMPORTANT

This symbol indicates tips and information about use of the appliance.



ENVIRONMENT

This symbol indicates tips and information about economical and ecological use of the appliance.

IMPORTANT SAFETY INSTRUCTIONS

Please read this user manual carefully and store in a handy place for later reference. Pass the user manual on to possible new owners of the appliance.

Read the following carefully to avoid damage or injury.

NOTE: You must read these warnings carefully before installing or using the appliance. If you need assistance, contact your Customer Care Department. The manufacturer will not accept liability, should these instructions or any other safety instructions incorporated in this book be ignored.



WARNING

General warnings

- This appliance must not be used as a space heater.
 - In order to avoid fire, the appliance must be kept clean and vents kept unobstructed.
 - Do not spray aerosols in the vicinity of this appliance whilst it is in operation.
 - Do not use or store flammable materials in this appliance storage drawer or near this appliance.
 - Do not line the bottom of the oven with foil or cookware.
 - Always use gloves when handling hot items inside the oven.
 - Always turn the grill off immediately after use as fat left behind may catch fire.
 - Do not modify this appliance.
 - To maintain safe operation, it is recommended that the product be inspected every 5 years by an authorised service person.
 - The cooking process must be supervised. A short term cooking process must be supervised continuously.
 - **Always clean the grill/oven dish after every use. Excessive fat build up may cause a fire.**
- ### Installation, cleaning and servicing warnings
- An authorised person must install this appliance. (Certificate of Compliance to be retained).
 - Before using the appliance, ensure that all packing materials are removed from the appliance.
 - In order to avoid any potential hazard, the enclosed installation instructions must be followed.
 - Ensure that all specified vents, openings and airspaces are not blocked.
 - Where the appliance is built into a cabinet, the cabinet material must be capable of withstanding 85°C.
 - Only authorised personnel should carry out servicing. (Certificate of Compliance to be retained).
 - Always ensure the appliance is switched off before cleaning or replacing parts.
 - Do not use steam cleaners, as this may cause moisture build up.
 - Always clean the appliance immediately after any food spillage.
 - This appliance must be earthed.
 - Due to the weight (built in 70kg) and size of cookers, 2 persons are required to manually manoeuvre them. Remove loose items such as oven racks and trays to minimise weight.
 - Do not use the handle to lift the cooker, instead open the oven door and lift the roof of the oven cavity.
 - Take care when lifting to avoid any sharp edges not intended for lifting.
 - This cooker must not be installed with a cut-off timer.
 - Disconnection in the fixed wiring must occur in accordance with AS/NZS 3000 wiring rules.
 - This appliance must be fixed in position or must be connected to the supply by a supply cord fitted with a male connector.

IMPORTANT SAFETY INSTRUCTIONS (continued)



WARNING

Oven

- During use the appliance becomes hot. Care should be taken to avoid touching the hot surfaces inside the oven.
- Switch the appliance off at the isolating switch before removing the oven light glass for globe replacement.
- To avoid an accident, ensure that oven shelves and fittings are always inserted into the appliance in accordance with the instructions.
- Do not use the door as a shelf.
- Do not push down on the open oven door.
- Do not cover the grill insert with foil, as fat left there may catch fire.
- Always keep the grill dish and baking tray clean as any residual fat may catch fire.



WARNING

Child safety

- This appliance is not intended for use by persons (including children) with reduced physical, sensory or mental capabilities, or lack of experience and knowledge, unless they have been given supervision or instruction concerning use of the appliance by a person responsible for their safety.
- Children should be supervised to ensure that they do not play with the appliance.
- During use this appliance becomes hot. Care should be taken to avoid touching hot surfaces, e.g. oven door, heating elements etc.
- Accessible parts will also become hot when in use. To avoid burns and scalds children should be kept away.

DESCRIPTION OF YOUR APPLIANCE

WVE915SC

Knob control electric oven



Control Panel



WVE915SCA, WVE915DSCA

Programmable electric oven

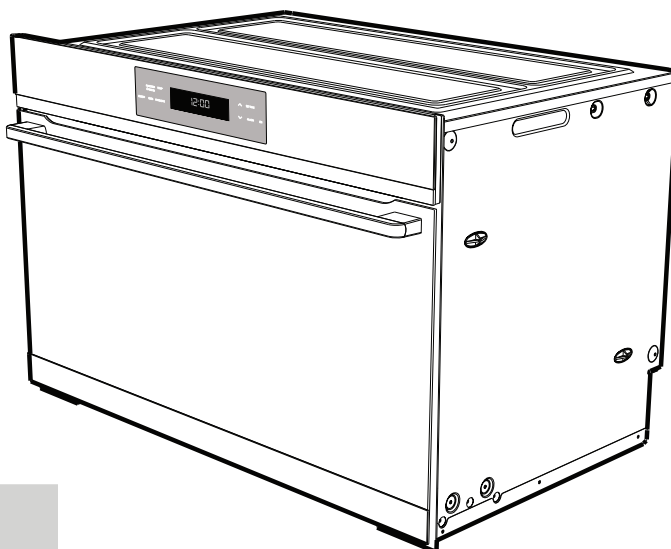

Control Panel



DESCRIPTION OF YOUR APPLIANCE (continued)

WVEP916SC

Pyro clean knob control electric oven

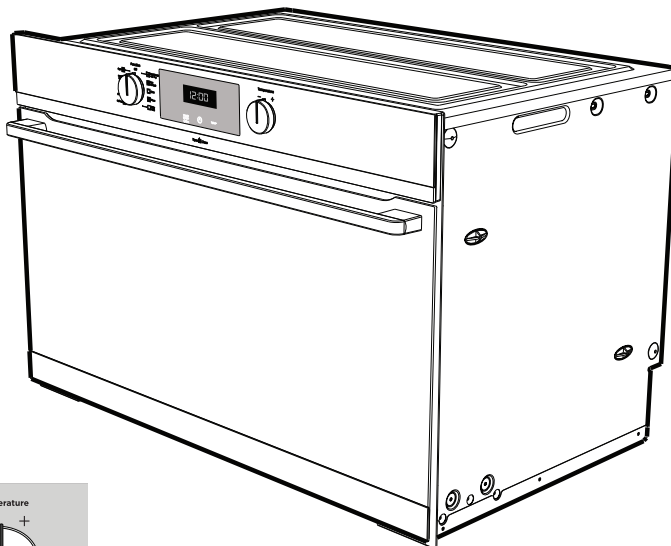

Control Panel

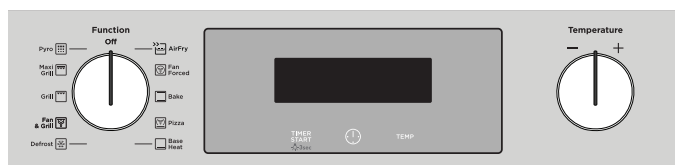

WVEP917DSC

Pyro clean programmable electric oven

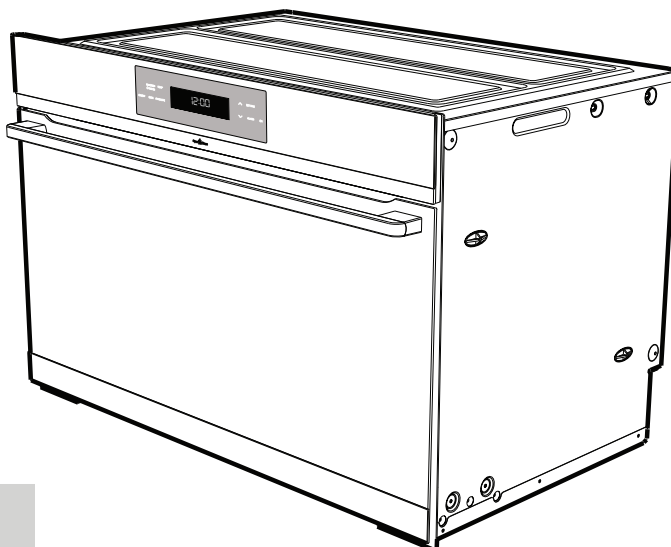

Control Panel



INSTALLATION OF THE APPLIANCE

Cabinet requirement

Models are designed to be built into cabinetry either below a benchtop or into a vertical cabinet.



WARNING

- The cooker must be installed and serviced only by an authorised person.
- A Certificate of Compliance MUST be supplied to be kept by the customer.
- The packing materials must be removed before you install the cooker.
- The surrounding kitchen cabinets must be able to withstand 85°C. Electrolux WILL NOT accept responsibility for damage caused by installation into kitchen cabinets which cannot withstand 85°C.
- The vents, openings and air spaces MUST NOT be blocked.
- You MUST NOT lift or pull the cooker by the door handle.
- The cooker MUST be checked every five years.
- If the supply cord is damaged, it must be replaced by the manufacturer, its service agent or similarly qualified persons in order to avoid a hazard.
- The appliance must not be installed behind a decorative door in order to avoid overheating.
- Due to the weight (70kg) and size of the cooker, 2 persons are required to install it.



IMPORTANT

To minimise the weight of the oven for easier installation, remove the oven door and oven internal accessory pack.

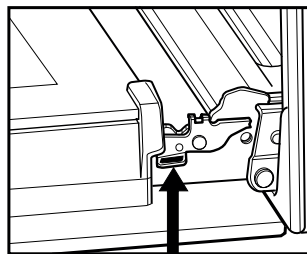

Locking tab up at normal position.

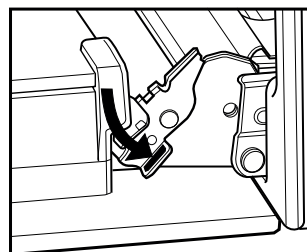

Press the locking tab down for removing the door.

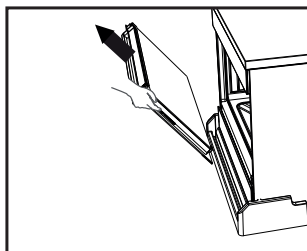

Gently close the door until it comes to a stop. Then lift the door off the hinge.

Leveling oven

Place a level in the oven as below making sure the level sits on the front and rear forms.

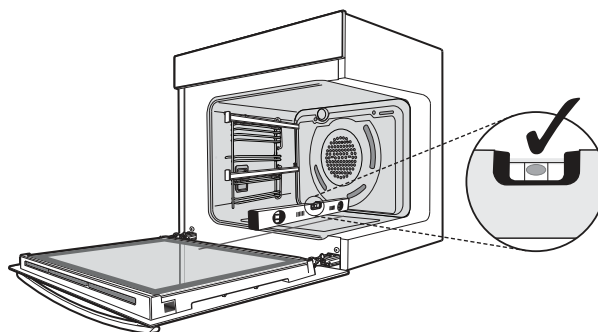

INSTALLATION (continued)

Underbench installation

Your underbench oven looks best when the control panel is directly under the benchtop. An upper infill panel may be added if the cooktop placed above the benchtop is too deep.

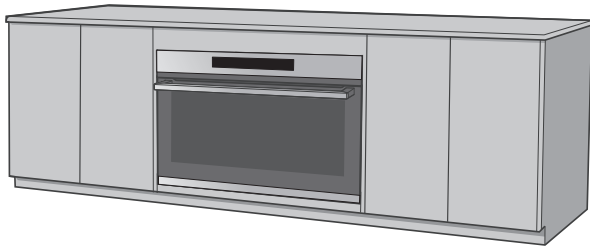

Vertical cabinet installation

The oven can be built into a vertical cabinet in the same manner as an underbench. The required cavity dimensions are the same and the product is secured to the cabinet in the same way.

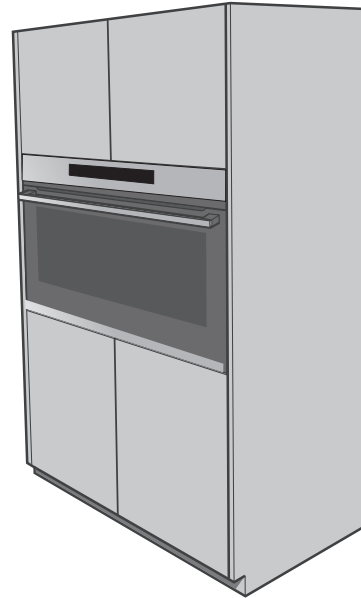

Oven dimensions

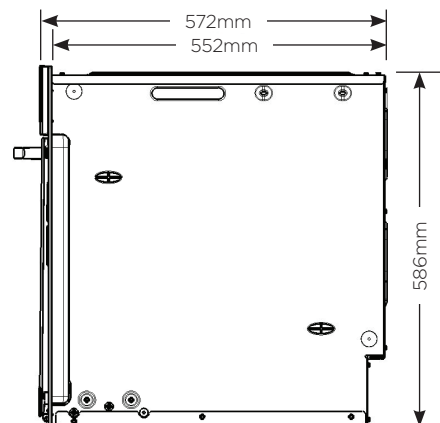
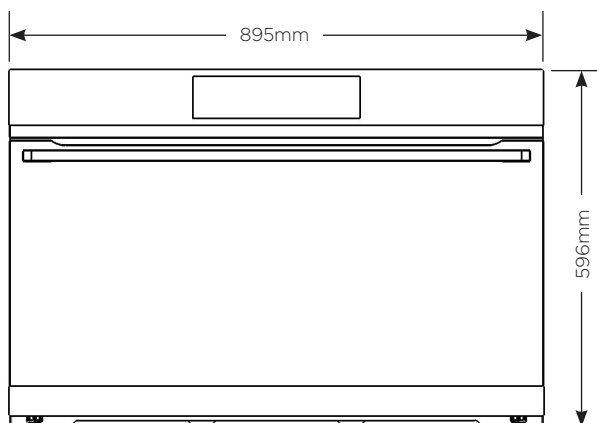

INSTALLATION (continued)

Cabinet construction for built in oven

For the best integration within a kitchen, install this appliance in a cupboard that gives a flush fit with the surrounding cupboard fronts. A recess of 20mm is ideal.

NOTE: Your appliance must be mounted on a horizontal surface for the full width and depth of the product.

NOTE: A ventilation slot 20mm wide is required at the rear of the base of the cabinet floor.

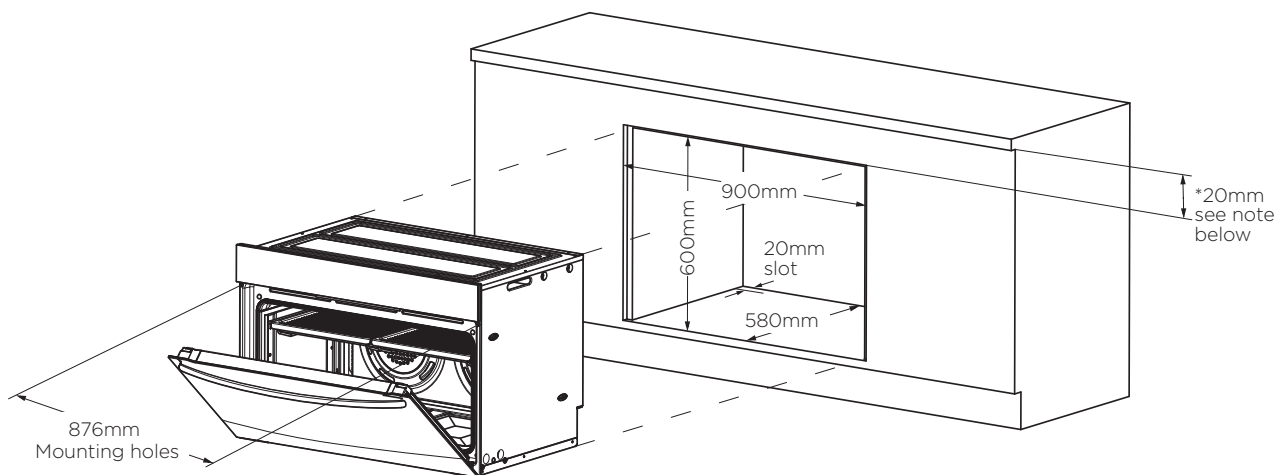
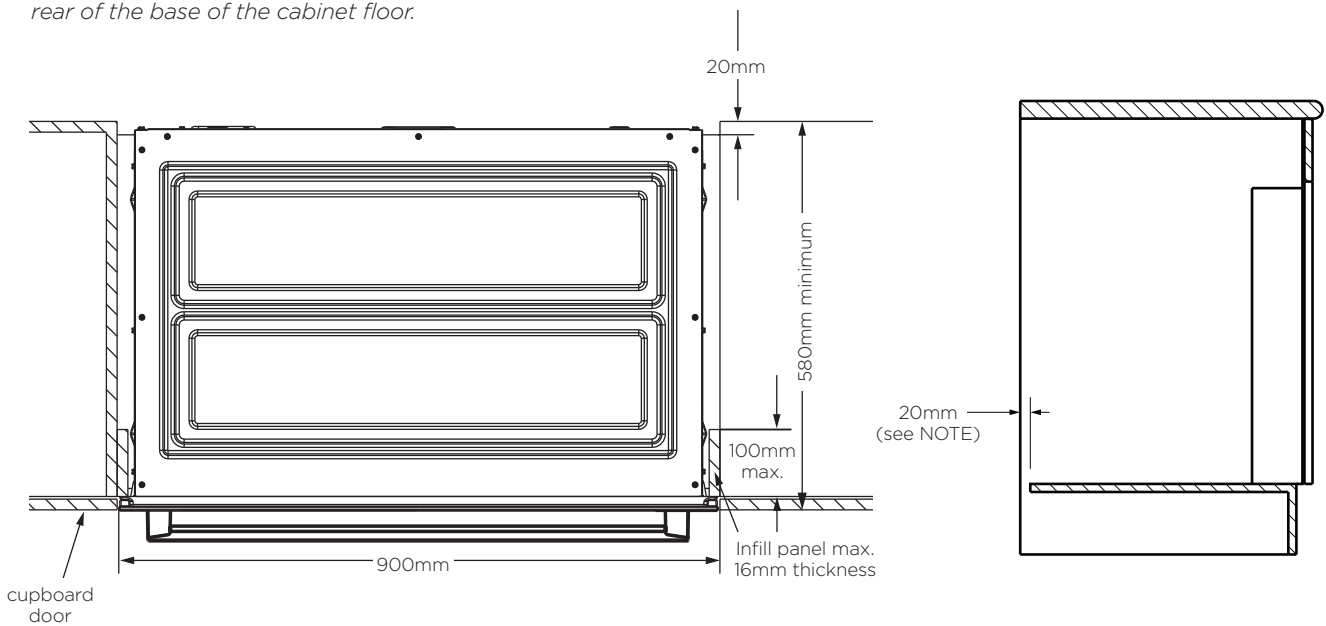

NOTE: If a powerpoint is fitted it must be accessible with the appliance installed.

*Refer to cooktop installation instructions for required clearance between cooktop and oven.

WIRING REQUIREMENTS

The cooker MUST be installed in compliance with:

- Wiring connections in AS/NZS 3000 Wiring Rules.
- Local regulations, municipal building codes and other statutory regulations.

For New Zealand Only:

The cooking range must be connected to the supply by a supply cord fitted with the appropriately rated plug that is compatible with the socket-outlet fitted to the final sub-circuit in the fixed wiring that is intended to supply this cooking range.

Supply cord size required:

WVE915SC/WVE915SCA/WVE915DSCA - 2.5mm²
 WVEP916SC/WVEP917DSC - 4.0mm²

The Data plate gives information about rating and is located behind the bottom of the oven door.

- A functional switch MUST be provided near the appliance in an accessible position (AS/NZS 3000).
- Wiring MUST be protected against mechanical failure (AS/NZS 3000).
- Disconnection in the fixed wiring must occur in accordance with the AS/NZS 3000 wiring rules.
- The cooker MUST be properly earthed.
- This range must be connected with cable of 75°C rating minimum.
- This product has passed the insulation resistance test after manufacture. If the resistance reading is low at installation, it is probably caused by moisture from the atmosphere being absorbed by the elements after the range has been produced. (pass at 0.01 MΩ AS/NZS 3000 Wiring Rules).

Note: When connections are made to a multi-phase 230/240V supply, the bridge piece MUST be removed from between the active connections.

Connecting to services and commissioning

This appliance must be installed by an authorised person, according to all codes and regulations of:

- ELECTRICAL supply authorities.
- Building regulations.
- Local government and council authorities.
- AS/NZS 5601.1.
- AS/NZS 3000.

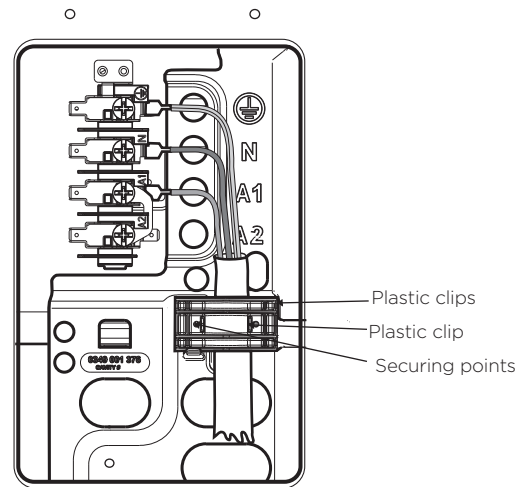

Hard wiring detail

1. Remove terminal cover plate from rear panel of appliance.
2. Fit wires through hole in back panel below terminal cover.
3. Engage wires into plastic clip. Secure plastic clip with two long silver screws (supplied in separate bag).
4. Replace cover plate onto rear panel.

Electrical connection location - built-in models

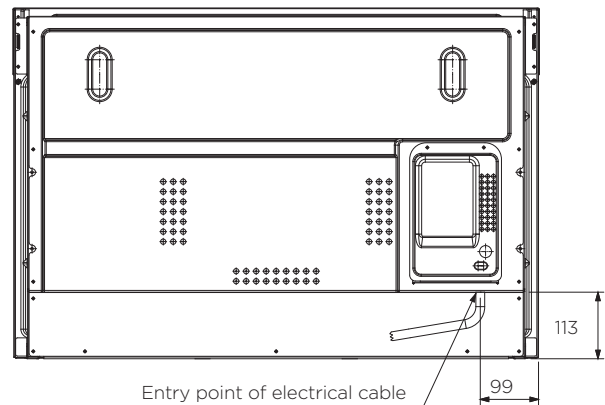

MODEL	TOTAL KW
WVE915SC	3.6
WVE915SCA	3.6
WVE915DSCA	3.6
WVEP916	5.2
WVEP917	5.2

BEFORE OPERATING YOUR APPLIANCE FOR THE FIRST TIME

Preparing your appliance for the first time

- Please remove all internal boxes and bags from the oven before operation.
- Please wipe out the oven interior prior to operation with warm soapy water and polish dry with a soft clean cloth. Do not close the oven door until the oven is completely dry.
- New appliances can have an odour during first operation. It is recommended to 'run in' your oven before you cook for the first time. Run the oven at 180°C for 2 hours and ensure that the room is well ventilated.
- DO NOT line the oven with foil, it will damage the enamel.
- Prior to installing accessories, remove all packaging and remove plastic film from external panels.

Setting the time

After electrically connecting the appliance, you must set the time of the day before you can operate your oven.



Touch control electronic clock model WVE915SC

1. After the appliance has been electrically connected "12:00" will be displayed and the "clock" indicator will flash.
2. To set the time of day, press **—** or **+**. 5 seconds after the last change, the "clock" indicator will disappear, confirming the time has been set.

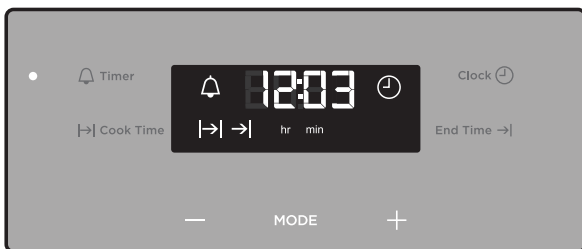
NOTE: The clock has a 24-hour display.



WVEP916SC electronic controller

1. When power is supplied to the oven the  clock icon will be displayed. Along with the clock symbol the "12" will be flashing. This indicates that the 'hour' portion of the time is ready to be changed.
2. Toggle the temp selector **—** or **+**, then touch  when the correct hour is displayed.
3. The minutes will then flash and can be set in the same manner as above. 5 seconds after the last change, the clock display will stop flashing, confirming that the time has been set.

NOTE: The clock has a 24-hour display.

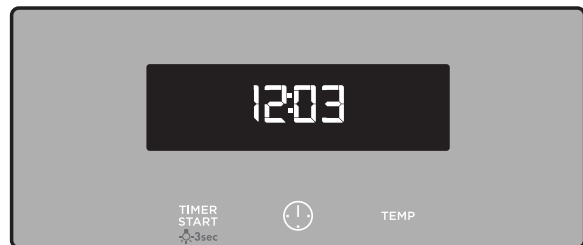

WVE915SCA, WVE915DSCA, WVEP917DSC electronic controller



When you connect the appliance to the mains, or reconnect after a power cut, the display contrast, the display brightness and the time of day all need to be set.

1. Press **^** or **v** to set the value.
2. Press **OK** to confirm.

INSTALLING YOUR OVEN ACCESSORIES

Slides (telescopic runners) (on selected models)

1. The selected models are supplied with a set of slides and instructions on how to assemble. Ensure the rack and slides are of the same hand, eg. left hand slide should be fitted on the left hand rack.
2. The instructions also show recommended slide positions on the rack.

Installing the slides (telescopic runners)

1. Obtain left hand side rack and left hand slide - see image to identify

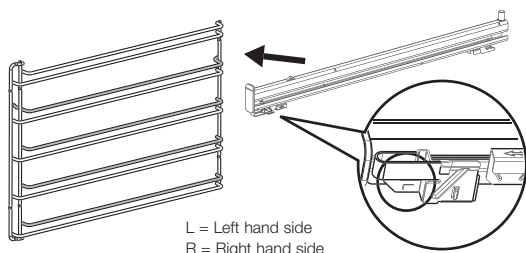

2. The shaded wires indicate the wire the slide can be mounted on. Fit slide rear clips to the rear of wire at an angle as shown below.

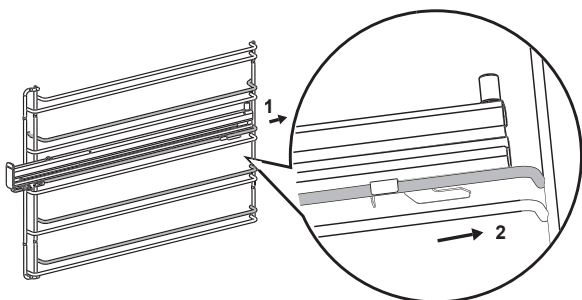

3. Push slide front clip over wire until secured.

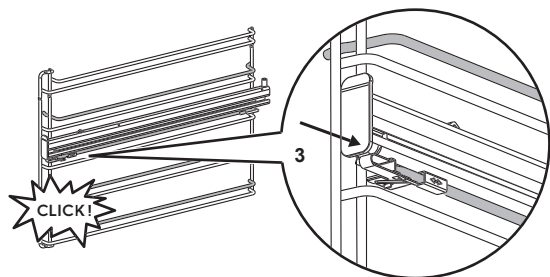

Installing the side racks

1. Insert the rear peg into the rear access hole

provided, ensuring peg is fully inserted.

2. Then locate the front peg into the front access hole and push in firmly.

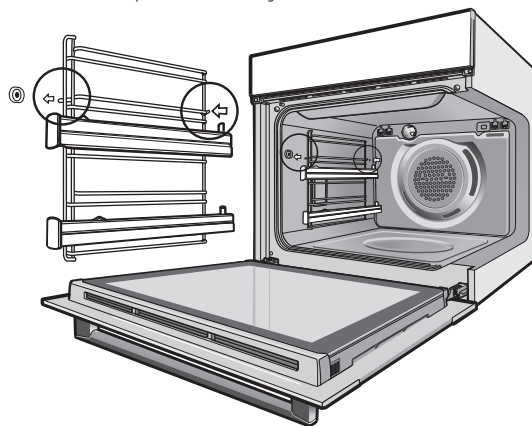

Fitting the shelves between the side rack wires

The shelves are designed so that they have maximum extension but cannot be accidentally pulled right out.

To fit a shelf to side racks:

1. Locate the rear edge of the shelf in between guide rails of the side rack - see diagram.
2. Ensure the same rail positions on both sides of the oven are being engaged. With the front edge raised, begin to slide the shelf into the oven.
3. Once the detents have passed the front edge of the side rack, the shelf can be pushed completely in. When fully inserted the shelf should not interfere with the closed oven door.

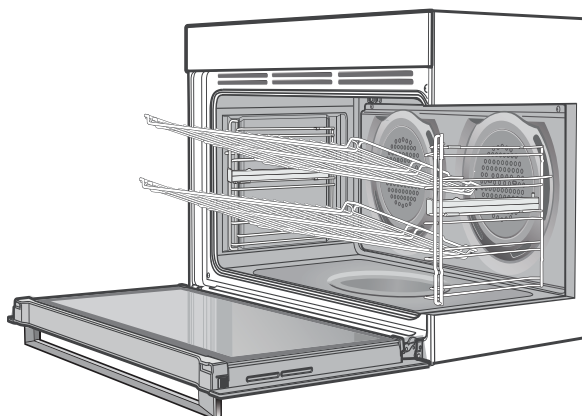

INSTALLING YOUR OVEN ACCESSORIES (continued)

Fitting grill dish and insert

Your oven comes with a full width grill dish and a grill insert. The grill dish insert is designed with flexibility to adjust distance between the food and the grill element.

Maximum grill power

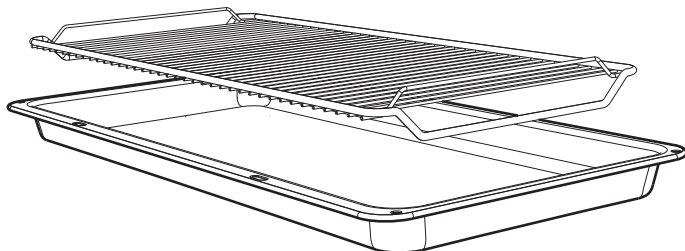

Grill dish insert brings the food closer to the grill element. Suitable when maximum grill power is needed.

Moderate grill power

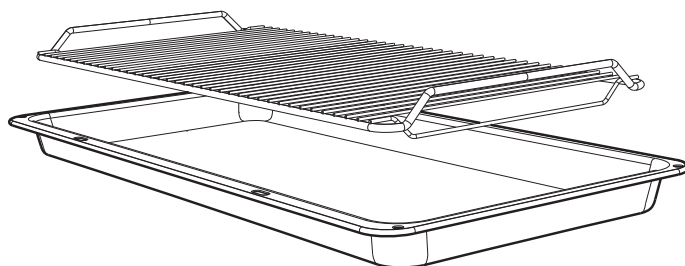

Food sits further away from the grill element. Suitable when moderate grill power is needed.

Fitting the AirFry

Selected models are supplied with an AirFry. The AirFry system consists of two parts, the outer frame and two mesh trays. The mesh trays sit in the outer frame. The AirFry can be placed onto slides or into side racks in the same manner as an oven shelf.

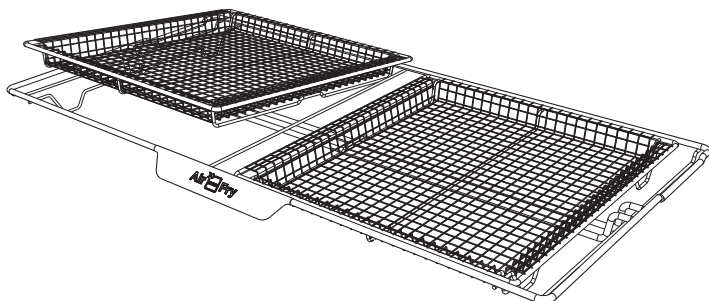

USING YOUR OVEN

Understanding your oven functions

Rapid Heat/AirFry



This function can be either used for a quicker pre-heat of your oven or used to turn your oven into an AirFry for your frying needs. Heat comes from the elements surrounding the fans as well as the smaller element above the food. This will heat up your oven 30% faster.

AirFry



Selected models are provided with an AirFry. The AirFry enables advanced convection cooking without having to turn the food, giving crispy great tasting results in a shorter time without all the oil. This is suitable for chips, chicken wings, nuggets and similar products. Heat comes from the elements surrounding the fans as well as the smaller element above the food.

Food items should be placed onto the mesh tray, spread out evenly and positioned in the middle of the oven. Set the function to AirFry and set the temperature as recommended.

Fan Forced/Fan Bake



Heat comes from the elements surrounding the fans. The fans circulate the hot air around the oven cavity so that you can put your food in different places in the oven and still cook them at the same time. You can use the "Fan Force" function for multi-shelf cooking, reheating cooked foods, pastries and complete oven meals. It will cook at a lower temperature and be faster than baking. Please note that some variation in browning is normal.

Easy Bake Steam

(WVEP917DSC model only)



Easy Bake Steam adds humidity at the beginning of the baking process. In bakery products, this allows the dough to rise and helps create a moist interior while obtaining a golden and crispy crust. Before preheating, when the oven is cold, add water to the cavity well. Refer to chapter 'Easy Bake Steam' for more details. For best results preheat the empty oven for 10 minutes prior to inserting food.

Bake/Pizza



Heat comes from two elements, one above and one below the food. The bottom element is a clean heat element and is below the floor of the oven. Both elements are controlled by the thermostat and will turn on and off to maintain the set temperature. You can use the "Bake/Pizza" function for pizza and single trays of biscuits, scones, muffins, cakes, slices, casseroles, baked puddings, roasts and delicate egg dishes.

Base Heat



Heat comes from the element below the floor of the oven. The Element is controlled by the thermostat and will turn on and off to maintain the set temperature. The "Base Heat" function can be used to add extra browning to the bases of pizzas, pies and pastries. Cook in the lower half of the oven when you are using only one shelf. For best results, use silver or shiny trays.

Fan Assist



Heat comes from two elements, one above and one below the food. The fans circulate the hot air around the oven cavity so that you can put the food in different places in the oven and still cook them at the same time. You should only use a maximum of 2 shelves with "Fan Assist". Do not use the bottom shelf. If two shelves are used, food on the shelf in the higher position will cook first and should then be removed to allow the food on the lower shelf to finish cooking.

USING YOUR OVEN (continued)

Pizza



“Pizza” is a combination of “Base Heat” and “Fan Forced” and offers you the combined benefits of both functions. Heat comes from the elements surrounding the fans as well as the clean heat element below the oven floor.

The “Pizza” function is ideal for foods that require cooking and browning on the base. It is great for foods such as pizzas, quiches, meat pies and fruit pies. Simply place the food in the middle of the oven and set the desired temperature.

Defrost



The “Defrost” function uses low temperature air that is circulated by the fans. You can defrost (thaw) your food before you cook it. You can also use “Defrost” to raise your yeast dough and to dry fruit, vegetables and herbs.

Fan & Grill



“Fan&Grill” offers you the benefits of both “Bake” and traditional “Grill” functions. The grill element turns on and off to maintain the set temperature while the fans circulate the heated air. The oven door remains closed for fan grill. You can use “Fan&Grill” for large cuts of meat to give you a result that is similar to “rotisserie” cooked meat. Put your food on a shelf in the second lowest shelf position. Put the grill dish on the lowest shelf position to catch any spills. When using “Fan&Grill” it is not necessary to turn the food over during the cooking cycle. Set the temperature to 180°C.

Grill



The “Grill” directs radiant heat from the powerful upper element onto the food. You can use the “Grill” function for tender cuts of meat, steak, chops, sausages, fish, cheese toasties and other quick cooking foods. Grill with the oven door closed. Preheat your grill for 3 minutes to get the best results. This will help seal in the natural juices of steak, chops etc. for a better flavour.

Left Grill

(WVEP917DSC model only)



‘The ‘Left Grill’ directs radiant heat from only one of the powerful upper elements onto the food. The ‘Left Grill’ function is used instead of ‘Full Grill’ when only half the amount of grill area is needed. Left Grill has 2 temperature settings, ‘LO’ and ‘HI’. Grill with the oven door closed.’

Maxi Grill/Full Grill



“Maxi Grill/Full Grill” directs radiant heat from 2 powerful upper elements onto the food. You can use the “Maxi Grill/Full Grill” function for tender cuts of meat, steak, chops, sausages, fish, cheese toasties and other quick cooking foods. Grill with the oven door closed. “Maxi Grill/Full Grill” allows you to take full advantage of the large grill dish area and will cook faster than normal “Grill”. For best results it is recommended to preheat your grill for 3 minutes. This will help seal in the natural juices of steak, chops etc. for a better flavour.

USING YOUR OVEN (continued)

Pyro Clean

(WVEP916SC & WVEP917DSC models only)



The oven has a Pyrolytic self-cleaning function. It cleans by burning off the spatters and accumulated dirt and grease from the oven liner, at high temperature. This process produces ash which can then be wiped out of the oven cavity.

Pyrolytic cleaning will not remove salt and mineral residue left in the cavity well when water evaporates. It is recommended that such residue is cleaned prior to conducting pyrolytic cleaning cycle.

Roast

(WVEP917DSC model only)



The Roast Function is designed for roasting meats and poultry by utilising heat from all elements in combination with the fan to surround the food. This provides even cooking throughout and enhanced browning. This function starts at a higher temperature to seal the meat. The oven will then automatically reduce to the selected temperature to cook the meat for as long as desired. For example, if you use the default 200°C the “Roast” cycle will start at 220°C and then lower to 200°C.

Cooling/Venting fan

Your built-in appliance is fitted with a cooling fan. This prevents your kitchen cabinet from overheating and reduces the condensation inside the oven. It will operate whenever you are using your oven or grill and will blow warm air across the top of the oven door. In some appliances the cooling fan may continue to operate after the appliance is turned off. It will switch off by itself once oven is cool.

Condensation

Excess condensation may fog the oven door. This may happen when you are cooking large quantities of food from a cold start. You can minimise condensation by:

- Keeping the amount of water used whilst cooking to a minimum.
- Making sure that the oven door is firmly closed.
- Baking custard in a baking dish that is slightly smaller than the water container.
- Cooking casseroles with the lid on.

NOTE: If you are using water in cooking, this will turn to steam and may condense outside your appliance. This is not a problem or fault with your oven.

Preheating your oven with rapid heat

To preheat your oven select the “Rapid Heat” function. This function allows your oven to reach the preset temperature quicker than any other cooking function.

1. Turn the function selector to “Rapid Heat”.
2. Set the desired preheat temperature, by rotating your oven temperature selector. When the indicator light above the temperature selector goes out, the oven has reached the desired temperature. Select the oven function you require for cooking or baking and place the food in the oven.

NOTE: WVE915SCA, WVE915DSCA and WVEP917DSC have Fast Heat Up function. See ‘Operating WVE915SCA, WVE915DSCA and WVEP917DSC’ chapter.

On completion of cooking

- The heat source will turn off, the timer will beep and the cook time ‘indicators’ will flash.
- Even though the heating element turns off the oven will still retain substantial heat. This will continue to cook the food until it is removed or the oven cools down. If you do not plan on being present when the oven turns off, you should take this extra heating time into account.
- Turn the function and temperature controls to the off position.
- Press any button to stop the timer beeping.

USING YOUR OVEN (continued)

Operating the touch control clock model WVE915SC

Select the cooking function

Turn the function selector in any direction to the desired cooking function. The oven cavity light will come on.

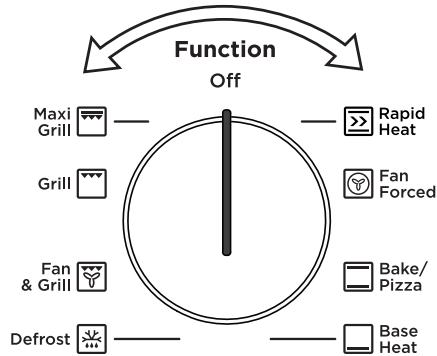

Select the temperature

To set the temperature, turn the temperature selector in a clockwise direction to the desired setting. An indicator light in the display will come on.

A thermostat controls the temperature in your oven. When the temperature is reached, the heating source switches itself off and the indicator light goes out. When the oven temperature falls below the desired setting, the heating source switches on and the indicator light comes on again.

Once the food is cooked, turn the temperature selector back in an anti-clockwise direction. Do not force it right round in a clockwise direction as this will result in damage to the thermostat.

NOTE: The desired cooking function must be selected before the oven will operate.

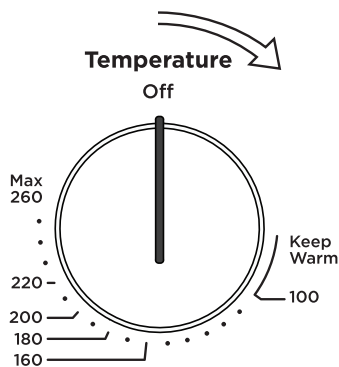

Cooking with timer

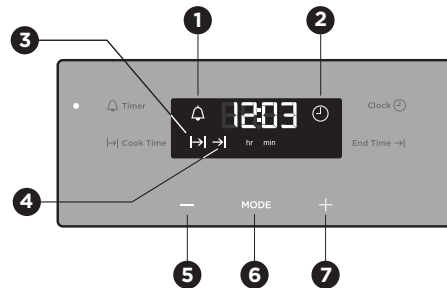

1. On when timer is set
2. Time of day icon
3. Cook time icon
4. End time icon
5. Minus
6. Touch to toggle through timer modes
7. Plus

Setting the time of day

Before the appliance can be used, the time must be set.

After the appliance has been electrically connected, '12:00' will be displayed and the clock icon will flash.

To set the time of day in hours and minutes touch the — or + symbols. Refer to the diagram above.

5 seconds after the last change, the clock icon will disappear, confirming the time has been set. Once the time has been entered, the clock advances minute by minute.

NOTE: The clock has a 24 hour display.

Change the time of day (Daylight saving)

1. Press **MODE** until the clock icon begins flashing.
2. Press — or + to change the time. 5 seconds after the last change, the clock icon will disappear, confirming the time has been set.

Setting the timer

1. Touch the **MODE** symbol until the timer icon begins flashing.
2. Set the countdown time you want by using — and +. 5 seconds after the last change the timer icon will stop flashing and the countdown will start in minutes.
3. To stop the beeper, touch any symbol.
4. Maximum countdown time is 2hrs 30mins.

USING YOUR OVEN (continued)

Setting the cooking duration

1. Check the clock displays the correct time of day.
2. Select the desired oven function and temperature. The oven indicator light will glow and the heating source will come on.
3. Press **MODE** until the cook time **|→|** icon begins flashing.
4. Set the cooking duration you want by using **—** or **+**. 5 seconds after the last change, the cook time **|→|** icon will stop flashing, and the time of day will be displayed.

NOTE: Do not forget to add preheating time if necessary.

To check or cancel settings

1. To check settings, touch the **MODE** symbol until the desired setting is displayed. The relevant icon will flash.
2. To cancel 'auto shut off', touch the **MODE** symbol until the cook time **|→|** icon flashes. Touch and hold the **—** symbol until the clock no longer reverses (at 0:00 a beep will be heard). This automatically cancels 'auto shut off'. If the temperature and function knobs are still at a setting, the oven will start once the cook time **|→|** icon stops flashing. Because 'auto off' is cancelled the oven will continue to heat until it is manually turned off.

On completion of cooking

The oven will turn off, the timer will beep and the cook time **|→|** icons will flash.

1. Turn the function and temperature controls to the off position.
2. Press **+** or **—** or **MODE** to stop the timer from beeping.

Switching the clock display ON and OFF

1. Press together **+** and **—** for 2 seconds to switch 'off' the display.
2. Press together **+** and **—** for 2 seconds to switch the clock display 'on' again.

NOTE: If a timer mode is set, then it is not possible to switch the display off.

USING YOUR OVEN (continued)

Operating WVEP916SC

Setting the time

Before the appliance, can be used, the time must be set.

When power is supplied to the oven the ⌚ clock icon will be displayed. Along with the clock symbol the '12' will be flashing. This indicates that 'hour' portion of the time is ready to be changed.

Toggle the temp selector + or —, then touch ⌚ when you have the right hour.

The minutes will flash and can be set in the same manner. 5 seconds after the last change, the clock display will stop flashing, confirming that the time has been set.

NOTE: The clock has a 24 hour display.

Select the oven function

Turn the oven function selector clockwise to select the desired oven function. The default temperature for that function will be shown on the display.

5 seconds after the last change, the oven will begin heating and the "Elapsed time" commences on the display.

NOTE: each oven function has a default temperature which can then be adjusted as outlined below.

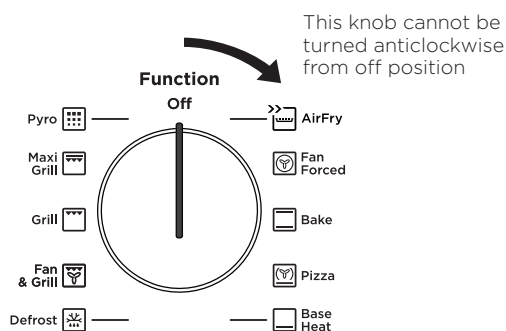

Selecting the oven temperature

Toggle the temperature selector left (←) or right (→) as required to set the desired cooking temperature. The temperature setting changes in increments of 5°C.

The set temperature is displayed for 5 seconds from the last change.

NOTE: the temperature can be adjusted at any time throughout the cooking time.

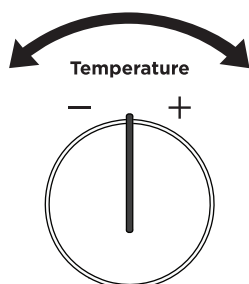

Cooking with the timer

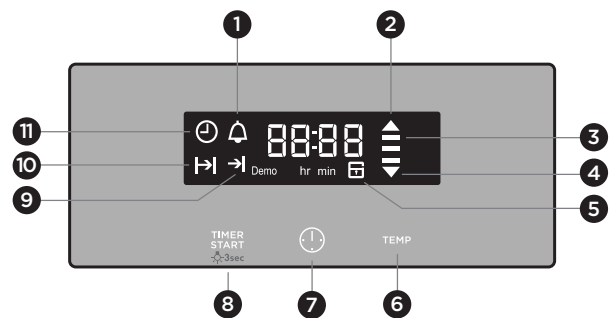

- 1 On when the timer is set
- 2 On when oven warming up
- 3 3 bars displayed when oven reaches set temperature
- 4 On when oven cooling down
- 5 Oven door locked
- 6 Touch to toggle through cooking time & oven set temp
- 7 Touch to toggle through the timer modes
- 8 Touch to start timer mode. Hold to turn oven light on/off
- 9 End time icon
- 10 Cook time icon
- 11 Time of day icon

Setting the cook time

1. Use the knobs to select the desired oven function and cooking temperature.
2. Touch the ⌚ button as often as necessary, until the 'cook time' ⏱ icon appears.
3. Set the desired cooking time commencing with minutes by using + or —, whilst the ⏱ icon is flashing, then touch the ⌚ button again and set the hours by using + or —. After 5 seconds from the last time adjustment the ⏱ icon will stop flashing. The appliance is now programmed and the display will countdown to zero.
4. When the set time has elapsed, a signal will sound and the appliance will turn off. To stop the signal, touch any button on the clock and then turn the oven function selector to OFF.

NOTE: Cooking time cannot be set for the Rapid Heat function.





The feature can be cancelled at any time by returning the function selector to OFF.

USING YOUR OVEN (continued)

Additional Functionality

Setting the countdown timer

Use this for timing any activity, for example baking bread.

1. Touch the  button, the display will flash.
2. Set the countdown time you want by using **+** and **-**. Commence with setting the number of seconds first. The minutes and hours can then be set by subsequently pressing the  button again and adjusting using **+** or **-**. 5 seconds after the last change the timer will stop flashing, confirming the timer has been set.
3. To cancel the timer touch the  button, the display will flash. Then touch and hold  and **TEMP** buttons until the timer is cleared.
4. To stop the beeper, touch any button.

NOTE: The clock display cannot be selected when the timer is operating.

Elapsed Time

When an oven function is selected (other than pyrolytic clean) an elapsed timer commences on the display.



To reset this timer touch and hold both the  and **TEMP** buttons until the timer is reset.

Displaying the oven temperature

During operation of the oven the current oven temperature during pre-heating of the oven can be displayed by touching the **TEMP** button. During normal operation the set temperature can be reviewed by touching the **TEMP** button.

NOTE: this temperature will only be displayed for approximately 5 seconds.

Light operation

During operation of the oven the light can be switched off by touching and holding the  button until the light turns off. Also the light can be turned on from the standby state by touching and holding the  button until the light comes on.

Activating the child-proof lock

When the child lock is engaged, the oven cannot be operated and the door cannot be opened.

1. Switch off the appliance using the function selector switch.
2. Touch and hold the  and **TEMP** buttons at the same time until the word 'SAFE' is displayed and a double beep is sounded. The word SAFE will be replaced by a padlock symbol on the display after 5 seconds.

Releasing the child-proof lock

Touch and hold the  and **TEMP** buttons at the same time until a double beep is sounded. This will commence to unlock the door and after 5 seconds the oven is ready for use.

Activating the function lock

The active function can be locked so it is not changed unintentionally.

1. The active function can be locked, to activate touch  and **TEMP** together until 'Loc' is displayed.
2. If the oven is switched-off while in 'Loc' it will switch into Child lock mode and the display will show 'SAFE'.
3. Oven can be released the same way as 'Releasing the child proof lock'

Safety Cut-out feature

The oven automatically switches itself off if the temperature is not adjusted or the appliance is left operating after a period of time. The oven switches itself off after:

- 12.5 hours when the temperature is set less than 120°C.
- 8.5 hours when the temperature is set to 120°C or above, and below 200°C.
- 5.5 hours when the temperature is set to 200°C or above, and below 250°C.
- 3.0 hours when the temperature is set at 250°C.

DEMO Mode

The oven can be set to operate in a demo mode (e.g. in a retail store). In this mode the display works and functions can be set but the oven does not actually heat. When in this mode the text 'DEMO' will be lit. The following instructions show how to enter and exit 'Demo' mode.

1. Ensure the oven is in the off state. Toggle and hold the selector to **+** until a beep sounds. The 'DEMO' text will begin to flash.
2. Toggle the temperature selector to set the first digit of display to 2. Touch clock to set.
3. Repeat step 2 until display shows 24:68. 3 beeps sound and DEMO will be shown.
4. To disable DEMO mode repeat steps 1 - 3.

USING YOUR OVEN (continued)

Operating WVE915SCA, WVE915DSCA & WVEP917DSC

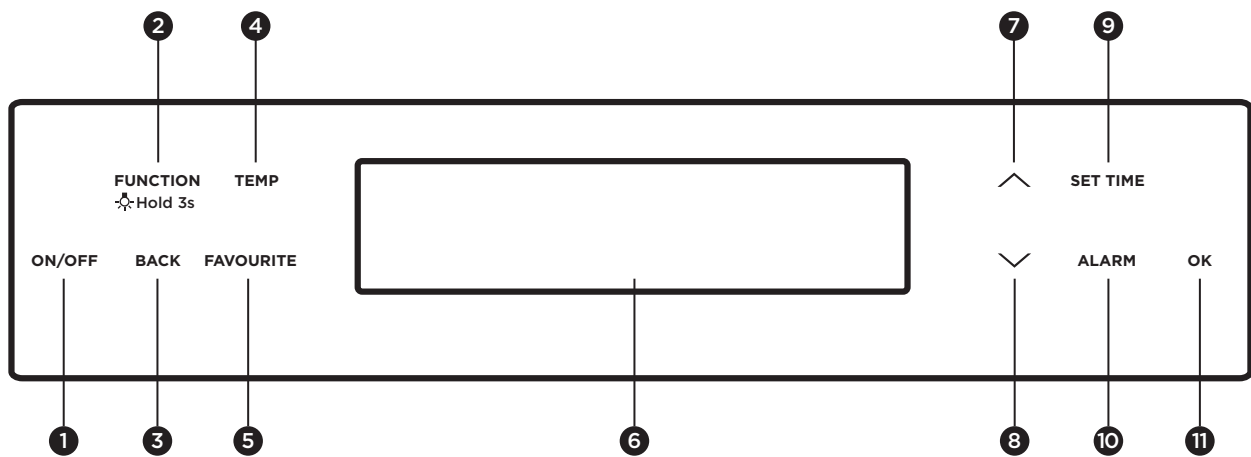

Use the sensor fields to operate the oven.

	FUNCTION	DESCRIPTION
1	ON/OFF	To turn the oven on and off
2	Heating functions or Assisted Cooking	Press the sensor field once to choose a heating function. To turn the light on or off, press the sensor field for 3 seconds
3	Back	To go back one level in the menu. To show the main menu, press the field for 3 seconds
4	Temperature selection/Fast Heat Up	To set the temperature or show the current temperature in the oven. Press the field for 3 seconds to turn the "Fast Heat Up" function on or off
5	Favourites	To save and access your favourite programs
6	Display	Shows the current settings of the oven
7	Up	To move up in the menu
8	Down	To move down in the menu
9	Time and additional functions	To set different functions. when a heating function operates, press the sensor field to set the timer or the "Function Lock" or "Favourites" functions
10	Minute minder	To set the "Minute Minder" function
11	OK	To confirm the selection or setting





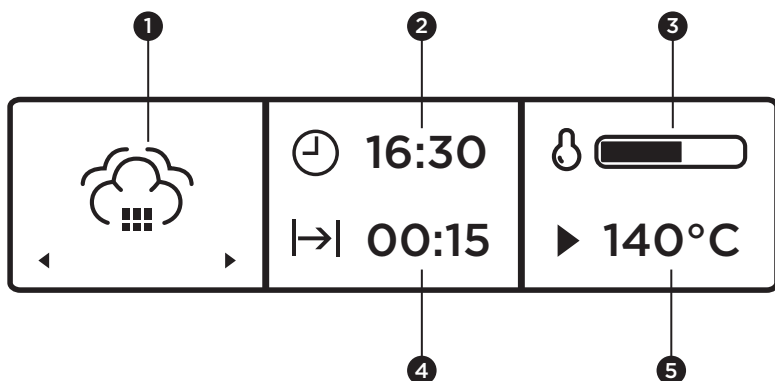



USING YOUR OVEN (continued)

Display





- ① Heating function
- ② Time of day
- ③ Heat-up indicator
- ④ Function duration/end time
- ⑤ Temperature

Other indicators of the display:

SYMBOL	FUNCTION	DESCRIPTION
	Minute minder	The function is currently working
	Time of day	The display shows the current time
	Duration	The display shows the necessary time for cooking
	End time	The display shows when the cooking time will be complete
	Temperature	The display shows the temperature
	Time indication	The display shows how long the heating function works. Press \wedge and \vee at the same time to reset the time
	Heat-up indicator	The display shows the temperature in the oven
	Fast heat up	The function is on. It decreases the heat up time

USING YOUR OVEN (continued)

Submenu for “Basic Settings”

SYMBOL	FUNCTION	DESCRIPTION
	Set time of day	Sets the current time on the clock.
	Time indication	When ON, the display shows the current time when you deactivate the appliance.
	Fast heat up	When on, fast heat up will be activated automatically in heating function. When off, the fast heat up can be activated by pressing TEMP for 3 seconds at the start of a heating function.
	Time extension	Activates and deactivates the time extension function.
	Display contrast	Adjusts the display contrast.
	Display brightness	Adjusts the display brightness.
	Buzzer volume	Adjusts the volume of press-tones and signals by degrees.
	Key tones	Activates and deactivates the tone of the touch fields. It is not possible to deactivate the tone of the ON/OFF touch field.
	Alarm/error tones	Activates and deactivates the alarm tones.
	Cleaning reminder	Reminds you when to clean the appliance (Pyrolytic models only).
	DEMO mode	Activation/deactivation code: 2468.
	Service	Shows the software version and configuration.
	Factory settings	Resets all settings to factory settings.
	Back	Back to previous menu

USING YOUR OVEN (continued)

Navigating the menus

1. Turn on the oven
2. Press \wedge or \vee to select the menu option
3. Press OK to move to the submenu or accept the setting

 At each point you can go back to the main menu with **BACK**

Setting a heating function

1. Turn on the oven.
2. Select a heating function.
3. Press **OK** to confirm.
4. Set the temperature.
5. Press **OK** to confirm.

Heat-up indicator



When you turn on a heating function, the bar on the display comes on. The bar shows that the temperature increases. When temperature is reached the buzzer sounds 3 times and the bar flashes and then disappears.

Fast Heat Up

This function decreases the heat-up time.

 Do not put food in the oven when the Fast heat up function is on.

To turn on the function, hold **TEMP** for 3 seconds. The heat-up indicator alternates.



The temperature bar moves horizontally to indicate that Fast Heat Up is on.

This function is not available for some oven functions.

Automatic Fast Heat Up

Fast Heat Up can be set to be automatically activated.



1. Go to Settings
2. Go to Fast Heat Up
3. Select ON or OFF to activate or deactivate automatic Fast Heat Up

Residual heat

When you turn off the oven, the display shows the residual heat. You can use the heat to keep the food warm.

Clock functions

Clock functions table

Symbol	Clock function	Application
	Minute Minder	To set a countdown (max. 2 h 30 min). This function has no effect on the operation of the oven. Use SET TIME to turn on the function. Press \wedge or \vee to set the minutes and OK to start.
	Duration	To set how long the oven works (max. 23 h 59 min).

If you set the time for a clock function, the time starts to count down after 5 seconds.

 If you use the clock functions: Duration, End Time, the oven turns off the heating elements after 90% of the set time. The oven uses the residual heat to continue the cooking process until the time ends (3 - 20 minutes).

Setting the clock functions

 Before you use the function: Duration, you must set a heating function and temperature first. The oven turns off automatically.

The function: Duration does not work when you use the core temperature sensor.

1. Set a heating function.
2. Press **SET TIME** again and again until the display shows the necessary clock function and the related symbol.
3. Press \wedge or \vee to set the necessary time.
4. Press **OK** to confirm.

When the time ends, a signal sounds. The oven turns off. The display shows a message.

5. Press any symbol to stop the signal.

Time Extension

The function: Time Extension makes the heating function continue after the end of Duration.

1. When the cooking time ends, a signal sounds. Press any symbol. The display shows the message.
2. Press **SET TIME** to turn on or **BACK** to cancel.
3. Set the length of the function.
4. Press **OK**.

USING YOUR OVEN (continued)

Additional Functions

Favourites

You can save your favourite settings, such as duration, temperature or heating function. They are available in the menu: Favourites. You can save 20 programs.

• Saving a favourite program

1. Turn on the oven.
2. Set a heating function or an automatic program.
3. Press **FAVOURITE** again and again until the display shows: *SAVE*.
4. Press **OK** to confirm.

The display shows the first free memory position.

5. Press **OK** to confirm.
6. Enter the name of the program. The first letter flashes.
7. Press \wedge or \vee to change the letter.
8. Press **OK**. The next letter flashes.
9. Do step 7 again as necessary.
10. Press and hold **OK** to save.

You can overwrite a memory position. When the display shows the first free memory position, press \wedge or \vee and press **OK** to overwrite an existing program.

You can change the name of a program in the menu: Edit Program Name.

• Activating a favourite program

1. Turn on the oven.
2. Press **FAVOURITE**.
3. Select your favourite program name.
4. Press **OK** to confirm.

Using the Child Lock

When the Child Lock is on, the oven cannot be turned on accidentally.

If the Pyrolysis function works, the door locks automatically. A message comes on in the display when you press any symbol.

1. Press **ON/OFF** to turn on the display.
2. Press **SET TIME** and **FAVOURITE** at the same time until the display shows a message. To turn off the Child Lock function, repeat step 2.

Function Lock

This function prevents an accidental change of the heating function. You can turn it on only when the oven works.

1. Turn on the oven.
2. Set a heating function or setting.
3. Press **TEMP** again and again until the display shows: Function Lock.
4. Press **OK** to confirm.

 If the Pyrolysis function works, the door is locked and the symbol of a key comes on in the display.

To turn off the function, press **TEMP**. The display shows a message. Press **TEMP** again and then **OK** to confirm.

 When you turn off the oven, the function also turns off.

Hints and tips

Automatic Switch-Off

For safety reasons the oven turns off automatically after some time, if a heating function works and you do not change any settings.

Temperature (°C)	Switch-off time (h)
30 - 115	12.5
120 - 195	8.5
200 - 245	5.5
250 - maximum	3
Pyrolytic Cleaning	4.5

 The Automatic Switch-off does not work with the functions: Light, Duration, End Time.

Brightness of the display

There are two modes of display brightness:

- Night brightness - when the oven is turned off, the brightness of the display is lower between 10pm and 6am.
- Day brightness:
 - when the oven is turned on.
 - if you touch a symbol during the night brightness (apart from **ON/OFF**), the display goes back to the day brightness mode for the next 10 seconds.
 - if the oven is turned off and you set the function: Minute Minder. When the function ends, the display goes back to the night brightness.

EASY BAKE STEAM

Your WVEP917DSC has the ability to add steam while baking. Cooking with steam is a great addition to straight 'hot air' cooking. Steam brings out all the natural flavours and goodness in the food, cooks evenly from surface to centre and retains more nutrients and vitamins. Steam assisted cooking consistently produces juicy, succulent interiors with crisp, golden exteriors.

WARNING

Risk of burns and damage to the appliance.

- Do not open the appliance door when the steam function operates, with the exception of preheating.
- Open the appliance door with care after the steam function stops.
- Refer to cleaning the appliance for cleaning after the steam function operates.

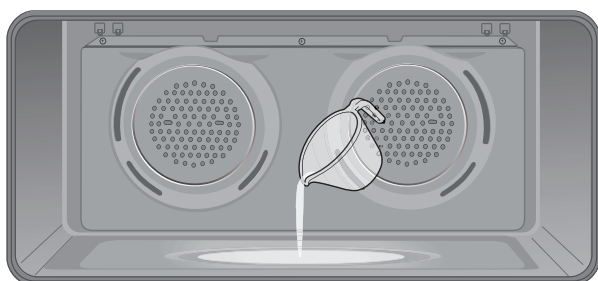

1. Open the oven door.
2. Fill the cavity well with 200ml of water (only when the oven is cold).
3. Set the 'Easy Bake Steam' function.
4. Set the temperature using the \wedge and \vee symbols.
5. Preheat the oven for 10 minutes or according to the recipe suggestions.
6. Place food in the appliance and close the oven door.

CAUTION

Do not refill the cavity well with water during cooking or when the oven is hot to avoid damage to enamel.

WARNING

Make sure that the appliance is cool before you remove the remaining water from the cavity well.

COOKING TEST

Get to know your new oven with this 'Simple Test Cake'

Although we strive for a perfect performing oven, it's possible that there will be some variation in colour when baking. Therefore, we suggest this simple, easy and delicious to make Simple Test Cake, it can help you understand your new oven. All ovens do sometimes have hot or cold spots, therefore it is important to judge with your eye as you may require to rotate during baking.

'Simple Test Cake'

125g butter, softened to room temperature

1 cup caster sugar

1 teaspoon pure vanilla essence

4 large eggs

2 cups self-raising flour

pinch of salt

4 tablespoons (80ml) full-cream milk

Method:

1. Butter base and sides of two 20cm straight-sided round or square cake pans. Then line the base with grease proof or baking paper.
2. Preheat oven to moderate '180°C' (170°C fan forced) and ensure oven shelf is in the centre position of oven.
3. Cream softened butter and sugar until light in colour.
4. Add vanilla essence.
5. Then eggs one at a time, beating well after each addition.
6. Sift flour and salt into the mixture and beat until well combined.
7. Add milk and beat or stir to combine.
8. Spoon mixture equally between prepared cake pans.
9. Bake in preheated oven, middle shelf for about 25 to 35 minutes or until when tested with a fine cake skewer it comes out clean, or the edges of the cakes have come away slightly from the sides of the cake pans.
10. Remove from oven to wire cake rack and rest for 5 minutes before removing from cake pans. Cool completely.

To Serve: sandwich together with your favourite jam or conserve, and dust top with pure icing sugar.

NOTE: If desired substitute butter for either margarine or olive oil spread. Recipe is based on the Australian standard metric 250ml cup and 20ml tablespoon sets.

COOKING GUIDE

- For best baking results preheat oven for 30 minutes.
- Select the correct shelf location for food being cooked.
- The grill tray can be used in the oven as a baking dish.
- Make sure dishes will fit into the oven before you switch it on.
- Keep edges of trays at least 40mm from the side of the oven. This allows free circulation of heat and ensures even cooking.
- Do not open the oven door more than necessary.
- Do not place foods with a lot of liquid into the oven with other foods. This will cause food to steam and not brown.
- After the oven is turned off it retains the heat for some time. Use this heat to finish custards or to dry bread.
- Do not use a lot of cooking oil when roasting. This will prevent splattering oil on the sides of the oven and the oven door. Polyunsaturated fats can leave residue which is very difficult to remove.
- For sponges and cakes use aluminium, bright finished or non-stick utensils.
- Remove unnecessary trays or dishes when roasting or baking.

Oven shelf location

Your oven has 5 positions for mounting the shelves or grill dish carrier. These are numbered from 1 (the lowest shelf position) to 5 (the highest shelf position). See diagram.

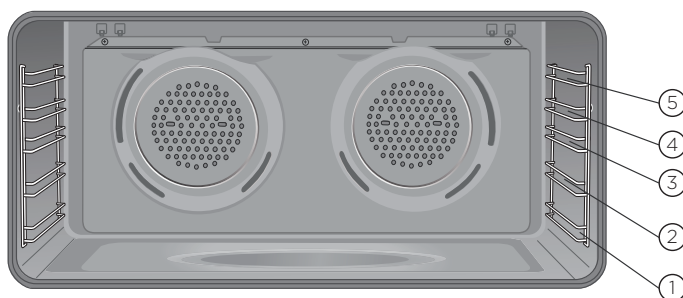

To give maximum space above and below the shelves, load them in this way:

- When cooking with 1 shelf, use position 2 or 3.
- When cooking with 2 shelves, use position 1 and 3.
- When grilling use position 4 or 5.

NOTE: Use the oven efficiently, by cooking many trays of food at the same time e.g. 2 trays of scones, small cakes or sausage rolls.

Choosing the best oven settings

The following table is intended as a guide and experience may show some variation in cooking times necessary to meet individual requirements. We recommend that you preheat your oven for 30 minutes.

Modes without oven fan

FOOD		TEMPERATURE °C	OVEN SHELF POSITION*	TIME IN MINUTES
Scones	Plain or fruit	220	2 or 3	10 - 15
Biscuits	Rolled	170	3	13 - 18
	Spooned	190	3	13 - 18
	Shortbread biscuits	160	3	30 - 35
Meringues	Hard - individual	110	3	90
	Soft - individual	180	3	15 - 20
	Pavlova - 6 egg	110	3	75
Cakes	Cup cakes	190	2 or 3	15 - 20
	Sponge - 4 egg	180	2 or 3	20 - 30
	Shallow butter cake	180	3	25 - 30
Pastry - short crust	Cornish pasties	200	3	40 - 45
	Custard tart	200/180	3	Pastry 8/200 Whole tart 10/200 & 20/180
Pastry - choux	Cream puffs	210	3	25 - 30
Yeast goods	Bread	210	3	25 - 30

Modes with oven fan

FOOD		TEMPERATURE °C	OVEN SHELF POSITION*		TIME IN MINUTES
			SINGLE SHELF	MULTI SHELF	
Scones	Plain or fruit	210	2 or 3	1 & 3	10 - 15
Biscuits	Rolled	150	2 or 3	1 & 3	13 - 18
	Spooned	180	2 or 3	1 & 3	13 - 18
	Shortbread	150	2 or 3	1 & 3	13 - 18
Meringues	Hard - individual	100	2 or 3	1 & 3	90
	Soft - individual	165	2 or 3	1 & 3	15 - 20
	Pavlova - 6 egg	100	2 or 3	1 & 3	75
Cakes	Cup cakes	180	2 or 3	1 & 3	15 - 20
	Sponge - 4 egg	170	2 or 3	1 & 3	20 - 30
	Shallow butter cake	170	2 or 3	1 & 3	25 - 30
	Rich fruit cake	170	2 or 3	1 & 3	60
Pastry - short crust	Cornish pasties	180	2 or 3	1 & 3	40 - 45
	Custard tart	190/170	2 or 3	1 & 3	20 - 30
	Whole tart				Pastry 8/190 Whole tart 10/190 & 20/170
Pastry - choux	Cream puffs	200	2 or 3	1 & 3	25 - 30
Yeast goods	Bread	200	3	1 & 3	25 - 30

* Counting from the bottom shelf up.

COOKING GUIDE (continued)

Easy Bake Steam function

FOOD		WATER IN CAVITY WELL (ML)	TEMPERATURE °C	OVEN SHELF POSITION*	TIME IN MINUTES
Yeast goods	Bread loaves	200	180 - 200	2 or 3	35 - 45
	Bread rolls	200	190 - 210	2 or 3	20 - 25
	Gluten free bread	200	180 - 200	2 or 3	40 - 50
	Pizza (fresh)	200	210 - 220	2 or 3	15 - 20
	Focaccia	200	160 - 170	2 or 3	20 - 30
Biscuits	Rolled	200	160 - 170	2 or 3	10 - 15
	Spooned	200	160 - 170	2 or 3	10 - 15
Scones	Plain or fruit	200	200 - 210	2 or 3	10 - 15
Cake	Cupcakes	200	180	2 or 3	20 - 25
	Sponge - 4 eggs	200	170	2 or 3	20 - 30
	Shallow butter cake	200	170	2 or 3	25 - 30
Pastry - choux	Cream puffs	200	200	2 or 3	20 - 30
Puff pastry		200	200	2 or 3	15 - 20
Frozen croissants		200	170 - 180	2 or 3	15 - 25

* Counting from the bottom shelf up.

Air Fry Cooking (for applicable models only)

The Air Fry feature works best for single shelf baking. Air Fry is suitable for French Fries, Chicken Wings, Chicken Nuggets and similar products, See settings in the table below.

IMPORTANT

- Air Fry is designed for single shelf cooking.
- Food should be arranged in a single layer on the Air Fry Tray.
- A separate tray should be placed on the bottom shelf position to catch any fat or crumbs dropping from the Air Fry Tray during cooking. This tray must be removed for normal baking.
- Some experimenting may be required to find the best cooking time.
- Food may need to be removed early and should be checked at minimum recommended bake time.
- Some frozen dense food with cook times less than 15 minutes may require additional baking time.

To Set the Air Fry Function:

1. Arrange food on to the Air Fry tray.
2. Select Air Fry setting and suggested temperature from the table below.
3. For best results pre-heat the oven
4. When the oven reaches the set temperature place the Air Fry tray on the suggested oven shelf position.

NOTE: Set the minute minder for the minimum suggested time and check for desired results when timer ends.

5. When cooking is complete turn the oven off.
6. Clean Air Fry tray after each use. Wash the tray in the sink with warm soapy water and a stainless-steel scourer.

FOOD		TEMPERATURE °C	OVEN SHELF POSITION*	TIME IN MINUTES
Potatoes	Frozen chips	220	2 or 3	18 - 20
	Potato wedges	220	2 or 3	20 - 23
Coated/battered goods	Chicken drummetts/wingettes with a dry rub	220	3	18 - 20
	Fresh Barramundi fillet with a crumb	210	3	18 - 20
Frozen goods	Chicken nuggets	230	3	18 - 20
	Crumbed fish	210	3	18 - 20
	Dim sims	230	3	18 - 20
	Hash browns	230	3	18 - 20
Steak	Scotch fillet, seared first	220	2 or 3	8 - 12 (rare/med)

NOTE:

** Count shelf position from the bottom up.*

A separate tray should be placed on the bottom shelf position to catch any fat or crumbs dropping from the Air Fry Tray during cooking. This tray must be removed for normal baking.

COOKING GUIDE (continued)

Roasting Meat

- Place the meat in the oven and set the temperature between 180°C and 200°C. (It is recommended to wrap your meats in an oven roasting bag or foil to prevent fats and oils from splattering, making it easier to clean your oven.)
- Use the grill (deep) dish and grill insert. Place the meat on the insert.
- Do not pierce the meat, as this will allow juices to escape.
- When the meat is cooked, take the roast out of the oven, wrap in aluminium foil and leave to stand for about 10 minutes. This will help retain the juices when the meat is carved. The table shows temperatures and cooking times for different kinds of meat. These may vary depending on the thickness or bone content of the meat.

MEAT	RECOMMENDED TEMPERATURE		MINUTES PER KG
Beef	180°C - 200°C	Rare	35 - 40
		Medium	45 - 50
		Well done	55 - 60
Lamb	180°C - 200°C	Medium	40
		Well done	60
Veal	180°C - 200°C	Well done	60
Pork	180°C - 200°C	Well done	60

Roasting poultry and fish

- Place the poultry or fish in an oven set at a moderate temperature of 180°C.
- Place a layer of foil over the fish for about three quarters of the cooking time.

NOTE: The table shows temperatures and cooking times for different kinds of fish and poultry. These may vary depending on the thickness or bone content of the meat.

POULTRY & FISH	RECOMMENDED TEMPERATURE	MINUTES PER KILOGRAM
Chicken	180°C - 200°C	45 - 50
Duck	180°C - 200°C	60 - 70
Turkey	180°C - 200°C	40 - 45 (<10kg)
		35 - 40 (>10kg)
Fish	180°C - 200°C	20

Grilling Guide



WARNING

Always clean the grill/oven dish after every use. Excessive fat build up may cause a fire.

Grilling is conducted with the oven door closed

As a method of cooking, grilling can be used to:

- Enhance the flavours of vegetables, fish, poultry and meat.
- Seal the surface of the food and retain the natural juices.

This table shows how to grill different types of meat:

Beef	Tenderloin, rump, sirloin. Brush with oil or melted butter, especially if the meat is very lean.
Lamb	Loin chops, short loin chops, chump chops, and forequarter chops. Remove skin or cut at intervals to stop curling. Brush with oil or melted butter.
Sausages	Prick sausages to stop skin from bursting.
Poultry	Divide into serving pieces. Brush with oil.
Fish	Brush with oil or melted butter and lemon juice.
Bacon	Remove rind. Grill flat.

Guide to better grilling

Steak	15 - 20 minutes
Chops	20 - 30 minutes
Fish	8 - 10 minutes
Bacon	4 - 5 minutes

No definite times can be given for grilling because this depends on your own tastes and the size of the food. These times should only be used as a guide and remember to turn the food over halfway through the cooking process.

For better grilling results, follow these easy instructions:

- Preheat grill for at least 5 minutes.
- Choose only prime cuts of meat or fish. If the cut is less than 5mm thick it will dry out. If the cut is more than 40mm thick, the outside may burn whilst the inside remains raw.
- Do not place aluminium foil under the food as this prevents fats and oils from draining away, which could result in a fire.
- Baste the food during cooking with butter, olive oil or marinade. Grilled food is better if marinated before cooking.
- Use tongs to turn food as a fork pierces the surface and will let juices escape.

Fan&Grill

The "Fan&Grill" function assists the grilling process by circulating the heat evenly around the food. The recommended temperature setting is 180°C for all fan grilling functions.

- Place the grill dish on the bottom rack.
- Place meat/poultry on an oven shelf above the grill dish.
- Wipe off any oil or fat which spatters while the oven is still warm.

DEALING WITH COOKING PROBLEMS

(see also TROUBLESHOOTING)

PROBLEM	CAUSES	REMEDIES
Uneven cooking:	<ul style="list-style-type: none"> • Incorrect shelf position. • Trays not centralised. • Air flow in oven uneven. • Grill/Baking dish affecting thermostat. 	<ul style="list-style-type: none"> - Select shelf that puts food in the centre of the oven. - Centre trays. - Rotate food during cooking. - Remove Grill/Baking dish from oven on bake modes.
Baked products too brown on top:	<ul style="list-style-type: none"> • Oven not preheated. • Baking tins too large for the recipe. • Baking tins not evenly spaced. • Products not evenly sized or spaced on trays. • Baking temperature too high. 	<ul style="list-style-type: none"> - Preheat the oven. - Use correct size tins. - Stagger baking tins at least 3cm between tins and the oven walls. - Make into same size and shape, & spread evenly over trays. - Lower the temperature.
Baked products too brown on bottom:	<ul style="list-style-type: none"> • Baking tins too large for the recipe. • Baking tins are dark metal or glass. • Food too low in the oven. • Oven door opened too frequently during baking. • Baking temperature too high. • Grill/Baking dish affecting thermostat. 	<ul style="list-style-type: none"> - Use correct size tins. - Change to shiny, light tins or lower the temperature by 10°C. - Cook one shelf higher. - Don't open the oven door until at least half the cooking time has passed. - Lower the temperature. - Remove Grill/Baking dish from oven on bake modes.
Cakes have a cracked, thick crust:	<ul style="list-style-type: none"> • Baking temperature too high. • Food too high in oven. • Cake batter over mixed. • Pan too deep. • Baking pans dark. 	<ul style="list-style-type: none"> - Lower the temperature. - Cook one shelf lower. - Mix just long enough to combine ingredients. - Check size of pan and use recommended size. - Change to shiny pans.
Baked products are pale, flat and undercooked:	<ul style="list-style-type: none"> • Baking temperature too low. • Food too low in oven. • Baking time too short. • Incorrect tin size. 	<ul style="list-style-type: none"> - Raise the temperature. - Cook one shelf higher. - Increase cooking time. - Use correct size tin.
Cakes fallen in the centre:	<ul style="list-style-type: none"> • Baking temperature too low. • Baking time too short. • Proportions of ingredients incorrect in the recipe. • Opening door too early in baking. 	<ul style="list-style-type: none"> - Raise the temperature. - Increase cooking time. - Check recipe. - Do not open the door until the last quarter of cooking time.
Roast meat and potatoes not browning in fan oven:	<ul style="list-style-type: none"> • Poor hot air circulation. • Grill/Baking dish affecting thermostat. 	<ul style="list-style-type: none"> - Elevate food onto a rack to allow air circulation. - Remove Grill/Baking dish from oven on bake modes.
Juices running out of meat:		<ul style="list-style-type: none"> - Do not pierce meat with fork, turn with tongs.
Grilled meats overcooked on outside and raw in the centre:		<ul style="list-style-type: none"> - Grill at lower insert position.
Grilled chops and steaks curling:		<ul style="list-style-type: none"> - Cut into fat every 2cm (1").

CLEANING YOUR OVEN



WARNING

- Always switch off power to the oven before cleaning.
- Do not line the bottom of the oven with foil or cookware.
- Do not use steam cleaners.

Stainless steel



WARNING

The oven door trim and the control panel are decorated with a special stainless steel that resists finger marks and should only be cleaned with warm water and a mild detergent. Do not use stainless steel cleaners, abrasive cleaners or harsh solvents on these parts.

NOTE: Make sure you follow the polish or brushing lines in the stainless steel.

- All grades of stainless steel can stain, discolour or become greasy. You must clean these regularly by following the procedures below if you want your appliance to look its best, perform well and have a long life.
- Care must be taken when wiping exposed stainless steel edges, they can be sharp!
- A suitable cleaner can be purchased from Electrolux Customer Care Centres.

Glass

- Glass surfaces on doors and control panels are best cleaned immediately after soiling.
- A damp cloth may help remove baked on food deposits.



WARNING

The door glass on this appliance is made from a tough, durable material that withstands heating and cooling without breaking. However, it must be remembered that it is GLASS, it may break. Treat it accordingly! Should you have any questions about the glass in your new appliance, please contact the customer care centre by dialling 1300 363 640.

Do not use harsh abrasive cleaners or sharp metal scrapers to clean the oven door since they can scratch the surface, which may result in the shattering of glass.

Oven

- Always keep your appliance clean. Ensure that fats and oils do not accumulate around elements or fans.
- Always keep the oven shelves, baking tray, grill dish and grill dish insert clean, as any fat deposits may catch fire.
- Always wrap your meats in foil or an oven roasting bag to minimise cleaning. Any polyunsaturated fats can leave a varnish-like residue which is very difficult to remove.

Removing the trays and shelves from your appliance

- Remove trays by simply pull them out taking care not to spill the contents.
- Slide shelves towards you until they reach the front stop.
- Tilt them up at the front to clear the side supports.
- Lift them clear.
- Wash the trays and shelves in hot soapy water.
- Reverse the above steps to put the trays and shelves back again.
- Ensure that they are placed between the 2 support wires.

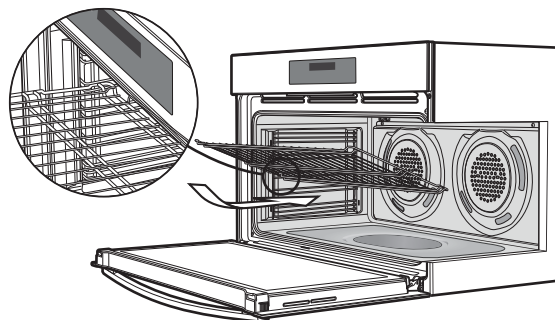

Removing the side racks or shelf supports

- Grasp the shelf support at the front.
- Pull it firmly inwards

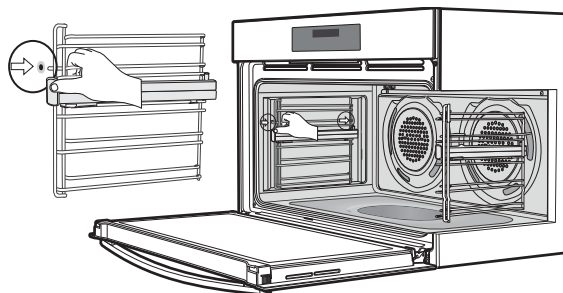

CLEANING YOUR OVEN (continued)

Cleaning your oven door

The oven door has been designed to allow the two inner door glasses to be removed for cleaning without removing the door from the product.

Removing the inner door glass for cleaning:

- Open the door fully to gain access to the hinges.
- Push down the hinge locking tab as shown in the diagram on both sides of door.

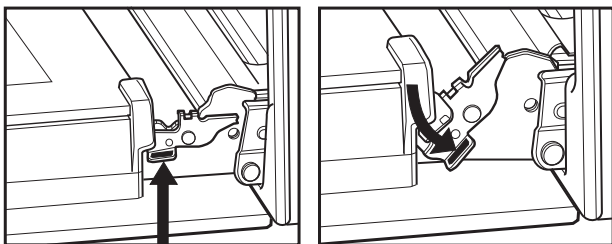

Locking tab up - normal position Locking tab down - for cleaning

- Gently close the door until it stops in partially open position on the locking tab (the door will not fully close with the locking tab in the down position).
- In this position the top door trim can be removed by pushing each side on the serrated surface to release the clips and lift the trim away from the door.
- To remove the inner glass, tilt top of glass towards the oven and lift out.
- The middle glass is removed in the same way.
- The inner side of outer glass can be cleaned in-situ when inner and middle glass is removed.
- Clean glass using detergent and warm water, wipe clean and dry thoroughly.

Re-assembling the door glass panels:

- Replace the middle glass back to the door. The middle glass is a clear pane and orientation of the glass is not important.
- Replace the inner glass back to the door, ensuring the side with black ceramic paint faces away from the oven cavity when door is closed.
- Fully open the door and return the locking tabs to their normal position and close the door.

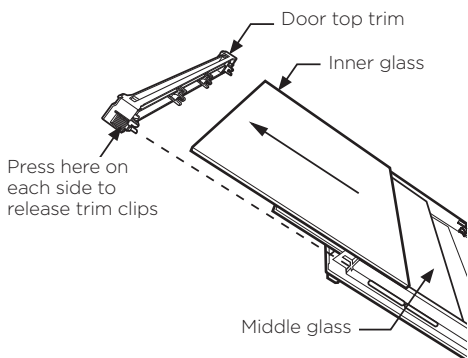

Cleaning your oven door



WARNING

- DO NOT use the oven without the inner and middle door glass fitted.
- NEVER spray any caustic cleaners on any surface of the door or damage to the surface coatings will result.
- DO NOT use metal utensils, scrapers, scourers, or abrasive cleaners to clean the glass or any of the door trims. These will damage or scratch the surface coatings and degrade the finish and appearance.
- DO NOT place glass in dishwasher.
- Use only warm water and liquid detergent with a soft cloth to clean the glass or trims.
- Before refitting the glass panes to the door ensure they are dried with a soft cloth.
- The glass edges have been specially ground to remove any sharp edges. However it is glass, and should be handled carefully to avoid injury to yourself and damage to the glass.



WARNING

Make sure the appliance power is switched off at the isolating switch before you remove or replace parts, to avoid the possibility of electric shock.

Changing the light globes

- There are 2 light globes located in the top of the oven cavity towards the front. The light globe glass is accessible between the passes of the upper element.
- To remove, turn oven light glass anti-clockwise.
- A special high temperature resistant globe should be used. This can be purchased from the customer care centre.

CLEANING YOUR PYROLYTIC OVEN

WVEP916SC & WVEP917DSC

Pyrolytic cleaning of the oven cavity

The oven has the Pyrolytic self-cleaning function, it cleans by burning off the spatters and accumulated dirt and grease from the oven liner, at high temperature. This process produces ash which can then be wiped out of the oven cavity. It is recommended you clean your oven regularly to keep the oven in its best condition.

- Light clean - this is an energy saving cycle that can be used on a regular basis if the oven is lightly soiled. Possibly after every 2nd or 3rd roast.
- Normal clean - use this as the regular cycle about once every 2-3 months.

Before carrying out the Pyrolytic cleaning function



WARNING

- Clean large deposits, spills or grease from the oven cavity.
- Please keep small children at a safe distance. The appliance becomes very hot.
- Never clean/leave non-stick baking trays and tins in the oven during the pyrolytic cycle. High temperatures damage the non-stick coating and poisonous gas is released.
- Pyrolytic cleaning can release fumes that are not harmful to humans, including infants or persons with medical conditions, however you are strongly advised to provide good ventilation during and after each pyrolytic cleaning process.
- Unlike humans, some birds and reptiles can be extremely sensitive to the potential fumes emitted during the pyrolytic cleaning process. It is strongly advised to remove any pets (especially birds) from the vicinity of the appliance during and after each pyrolytic cleaning process.
- Small pets can also be highly sensitive to the localised temperature changes in the vicinity of all pyrolytic ovens when the pyrolytic self cleaning program is in operation.



CAUTION

- All accessories must be removed from the oven, including shelves, trays and side racks.
- During pyrolytic cleaning the air outlet vent above the door must be kept clear of any obstruction (e.g. tea towels).
- Do not use your oven to clean miscellaneous items (e.g. cookware).
- To prevent damage, do not use acids, sprays or similar cleaning agents.



IMPORTANT

During the pyrolytic cleaning function, it is advisable not to use a cooktop if it is fitted above the oven. This could cause overheating and damage to both appliances. The cooling fan will operate at an increased speed for Pyrolytic cleaning and will continue to run until the oven has cooled down. It is recommended to use the Pyro clean function regularly to keep the oven in its best condition.

Starting the Pyrolytic cleaning function WVEP916SC

- Make sure all accessories are removed from the oven including shelves, trays and side racks.
- Turn the oven "Function" selector clockwise to select the "Pyro" position.
- Use the $+$ or $-$ buttons on the electronic clock to select between a pyrolytic cleaning time of 1:30 hours (light clean) or 2:30 hours (normal clean) for the appropriate level of cleaning.
- After 5 seconds from the last change, the oven will begin heating and the "Remaining time" will be displayed.
- The pyrolytic cleaning function can be stopped at any time during the cycle by turning the function selector counter-clockwise to the "OFF" position.

NOTE: The "Remaining time" does not include cool-down time for the oven.

Pyrolytic cleaning programmable controller WVEP917DSC

- Switch on the appliance by pressing **ON/OFF**.
- Press \wedge or \vee to go to 'Pyrolytic Cleaning' function. Press **OK** to confirm.
- Press \wedge or \vee to choose between "1hrs 30 min" (light clean), "2hrs" (normal clean) or "2hrs 30 min" (heavy clean) for the appropriate level of cleaning.
- Press **OK** to commence the cleaning process.
- The oven will begin heating and the "Remaining Time" will be displayed.
- The pyrolytic cleaning function can be stopped at any time during the cycle by pressing **ON/OFF**.

During Pyrolytic cleaning

When the temperature in the oven approaches 300°C, the door will automatically lock and a padlock symbol will appear on the display.

CLEANING YOUR PYROLYTIC OVEN (continued)

After Pyrolytic cleaning

The door will only unlock when the oven has cooled to a safe temperature. Turning the function off will not unlock the door.

After cool-down, wipe the ash out of the oven with a soft damp cloth and warm water. To restore the enamel shine to more difficult areas, use a damp cloth with vinegar and detergent.



CAUTION

Do not turn off the mains power supply to the oven during the pyrolytic cleaning cycle. This could damage the appliance and its vicinity.

Cleaning the cavity well

The cleaning procedure removes limestone residue from the cavity well after cooking with steam



WARNING

Perform the cleaning procedure at least every 5 EasyBake + Steam cooking cycles.

1. Mix 150ml of tap water with 100ml of white vinegar and put the mix in the cavity well.
2. Let the water and vinegar mix dissolve the limestone residue at the ambient temperature for 45 minutes.
3. Remove the water and vinegar mix with a soft cloth and clean cavity with warm water and a soft cloth.

TROUBLESHOOTING

Faults

If there is a problem with the oven and/or grill, please:

- Check the points listed below before calling for service. It may be possible to avoid a call by fixing the problem yourself – and so continue cooking.

NOTE: We may charge for service even in the guarantee period if your problem is due to the causes listed below.

PROBLEM	POSSIBLE CAUSE	WHAT TO DO
Oven or grill not working	Power not turned on Household fuse blown Controls incorrectly set Circuit breaker tripped Clock not set Demo Mode 'ON' (for WVE915SCA, WVE915DSCA, WVEP916, WVEP917) Child Lock 'ON' (for WVE915SCA, WVE915DSCA, WVEP916, WVEP917)	Switch on electricity Check fuses Reset controls Check circuit breaker Set time of day on timer Deactivate DEMO Mode. Refer to 'Using your oven' Deactivate Child Lock. Refer to 'Using your oven'
Oven not heating enough	Foil or trays on bottom of oven Oven not pre-heated	Remove foil or trays Pre-heat oven for 30 minutes.
Light & fans on continuously	Timer not in manual mode	Set timer to manual mode
Oven not working	Timer not in manual mode Household fuse blown	Set timer to manual mode Check fuses
Oven light not working	Household fuse blown Circuit breaker tripped Lamp blown or loose in socket	Check fuses Check circuit breaker Replace or tighten lamp
Cooker smoking when first used	Protective oils being removed	Turn grill on high for 30 mins and then the oven on 220°C for 1 hour
Too much condensation building up when baking	Too much water used when cooking	Reduce amount of water Leave oven door open after cooking
Smells when first using oven	Protective oils being removed	This is normal
Timer flashing	Power failure or interruption	Reset time of day
Shelf or telescopic runner slides out when door is opened	Oven cavity is not level with the ground.	Perform a check using a level to verify cause (refer to installation section). If not level refer to installer
Oven seal is loose	The oven seal is only attached at each corner. It may seem like a loose fit but when the oven door is closed it will function correctly	No action necessary
There is warm air coming from the top of the oven door	The oven vent is located under the control panel. When the oven is on, the air passes through this vent. This venting is necessary for proper air circulation in the oven and good baking results. Do not block vent.	No action necessary

NOTE: Only authorised personnel should carry out servicing. If the household fuse continues to blow, call the Customer Care Centre.

Further Information

When you need information, service or replacement parts or have a warranty enquiry, please contact the Customer Care Centre:

Australia - 1300 363 640, 8.00am- 5.00pm EST Monday to Friday

New Zealand - 09 573 2384, 8.00am - 5.00pm EST Monday to Friday

Please have the following information ready: Model, Model Number & Serial Number. This is shown on the data plate which is visible when the oven door is open.



FOR SALES IN AUSTRALIA AND NEW ZEALAND
 APPLIANCE: WESTINGHOUSE BUILT-IN OVENS, COOKTOPS AND
 FREESTANDING COOKER

This document sets out the terms and conditions of the product warranties for Westinghouse Appliances. It is an important document. Please keep it with your proof of purchase documents in a safe place for future reference should there be a manufacturing defect in your Appliance. This warranty is in addition to other rights you may have under the Australian Consumer Law.

1. In this warranty:

- (a) 'ACL' or 'Australian Consumer Law' means Schedule 2 to the Competition and Consumer Act 2010;
- (b) 'Appliance' means any Electrolux product purchased by you and accompanied by this document;
- (c) 'ASC' means Electrolux's authorised serviced centres;
- (d) 'Westinghouse' is the brand controlled by Electrolux Home Products Pty Ltd of 163 O'Riordan Street, Mascot NSW 2020, ABN 51 004 762 341 in respect of Appliances purchased in Australia and Electrolux (NZ) Limited (collectively "Electrolux") of 3-5 Niall Burgess Road, Mount Wellington, in respect of Appliances purchased in New Zealand;
- (e) 'Warranty Period' means the period specified in clause 3 of this warranty;
- (f) 'you' means the purchaser of the Appliance not having purchased the Appliance for re-sale, and 'your' has a corresponding meaning.

2. Application: This warranty only applies to new Appliances, purchased and used in Australia or New Zealand and is in addition to (and does not exclude, restrict, or modify in any way) other rights and remedies under a law to which the Appliances or services relate, including any non-excludable statutory guarantees in Australia and New Zealand.

3. Warranty Period: Subject to these terms and conditions, this warranty continues in Australia for a period of 24 months and in New Zealand for a period of 24 months, following the date of original purchase of the Appliance.

4. Repair or replace warranty: During the Warranty Period, Electrolux or its ASC will, at no extra charge if your Appliance is readily accessible for service, without special equipment and subject to these terms and conditions, repair or replace any parts which it considers to be defective. Electrolux may, in its absolute discretion, choose whether the remedy offered for a valid warranty claim is repair or replacement. Electrolux or its ASC may use refurbished parts to repair your Appliance. You agree that any replaced Appliances or parts become the property of Electrolux.

5. Travel and transportation costs: Subject to clause 7, Electrolux will bear the reasonable cost of transportation, travel and delivery of the Appliance to and from Electrolux or its ASC. Travel and transportation will be arranged by Electrolux as part of any valid warranty claim.

6. Proof of purchase is required before you can make a claim under this warranty.

7. Exclusions: You may not make a claim under this warranty unless the defect claimed is due to faulty or defective parts or workmanship. This warranty does not cover:

- (a) light globes, batteries, filters or similar perishable parts;
- (b) parts and Appliances not supplied by Electrolux;
- (c) cosmetic damage which does not affect the operation of the Appliance;

- (d) damage to the Appliance caused by:
 - (i) negligence or accident;
 - (ii) misuse or abuse, including failure to properly maintain or service;
 - (iii) improper, negligent or faulty servicing or repair works done by anyone other than an Electrolux authorised repairer or ASC;
 - (iv) normal wear and tear;
 - (v) power surges, electrical storm damage or incorrect power supply;
 - (vi) incomplete or improper installation;
 - (vii) incorrect, improper or inappropriate operation;
 - (viii) insect or vermin infestation;
 - (ix) failure to comply with any additional instructions supplied with the Appliance;

In addition, Electrolux is not liable under this warranty if:

- (a) the Appliance has been, or Electrolux reasonably believes that the Appliance has been, used for purposes other than those for which the Appliance was intended, including where the Appliance has been used for any non-domestic purpose;
- (b) the Appliance is modified without authority from Electrolux in writing;
- (c) the Appliance's serial number or warranty seal has been removed or defaced

8. How to claim under this warranty: To enquire about claiming under this warranty, please follow these steps:

- (a) carefully check the operating instructions, user manual and the terms of this warranty;
- (b) have the model and serial number of the Appliance available;
- (c) have the proof of purchase (e.g. an invoice) available;
- (d) telephone the numbers shown below.

9. Australia: For Appliances and services provided by Electrolux in Australia: Electrolux goods come with guarantees that cannot be excluded under the Australian Consumer Law. You are entitled to a replacement or refund for a major failure and for compensation for any other reasonably foreseeable loss or damage. You are also entitled to have the Appliance repaired or replaced if the Appliance fails to be of acceptable quality and the failure does not amount to a major failure. 'Acceptable quality' and 'major failure' have the same meaning as referred to in the ACL.

10. New Zealand: For Appliances and services provided by Electrolux in New Zealand, the Appliances come with a guarantee by Electrolux pursuant to the provisions of the Consumer Guarantees Act, the Sale of Goods Act and the Fair Trading Act. Where the Appliance was purchased in New Zealand for commercial purposes the Consumer Guarantee Act does not apply.

11. Confidentiality: You accept that if you make a warranty claim, Electrolux and its agents including ASC may exchange information in relation to you to enable Electrolux to meet its obligations under this warranty.

Important Notice

Before calling for service, please ensure that the steps listed in clause 8 above have been followed.

AUSTRALIA	FOR SERVICE or to find the address of your nearest authorised service centre in Australia PLEASE CALL 13 13 49 <small>For the cost of a local call</small>	FOR SPARE PARTS or to find the address of your nearest spare parts centre in Australia PLEASE CALL 13 13 50 <small>For the cost of a local call</small>
NEW ZEALAND	FOR SERVICE or to find the address of your nearest authorised service centre in New Zealand PLEASE CALL 0800 10 66 10	FOR SPARE PARTS or to find the address of your nearest spare parts centre in New Zealand PLEASE CALL 0800 10 66 20

For more information on all Westinghouse appliances, or for dimension and installation information, call into your retailer, phone or email our customer care team or visit our website:

AUSTRALIA

phone: 13 13 49

email: customercare@electrolux.com.au

web: westinghouse.com.au

NEW ZEALAND

phone: 0800 10 66 10

email: customercare@electrolux.co.nz

web: westinghouse.co.nz

 and WESTINGHOUSE are trademarks of Westinghouse Electric Corporation.
Used under license by Electrolux Home Products Pty Ltd. All Rights Reserved.

Part Number: A20803602 REV C
© 2022 Electrolux Home Products Pty Ltd
ABN 51 004 762 341
W_MAN_90cm_Ovens_A4_Dec22