



**TOP-LOAD
WASHING MACHINE**

WWT1284M7WA



Westinghouse

**Enjoy peace of mind.
Register your appliance today.**

Stay updated on better living services,
safety notices and shop for accessories.

- 1. Open the camera app
on your smartphone
and point at the QR
code to scan.**

Product Registration QR code is
located on the front of your appliance
or back of the control panel.



- 2. Tap the notification or link to open the
registration form.**



- 3. Complete your details and enjoy peace
of mind.**

IMPORTANT INFORMATION THAT MAY IMPACT YOUR MANUFACTURER'S WARRANTY

Adherence to the directions for use in this manual is extremely important for health and safety. Failure to strictly adhere to the requirements in this manual may result in personal injury, property damage and affect your ability to make a claim under the Westinghouse manufacturer's warranty provided with your product. Products must be used, installed and operated in accordance with this manual. You may not be able to claim on the Westinghouse manufacturer's warranty in the event that your product fault is due to failure to adhere to this manual.

CUSTOMER CARE AND SERVICE

We recommend the use of original spare parts. When contacting Service, ensure that you have the following data available. The information can be found on the rating plate. Model, PNC, and Serial Number.

-  Warning / Caution-Safety information.
-  General information and tips.
-  Environmental information.

Subject to change without notice.

CONTENTS

1.  SAFETY INFORMATION.....	4	7. CARE AND CLEANING.....	25
1.1 Conditions Of Use	4	7.1 What To Do After You Have Finished Your Washing.....	25
1.2 Child Safety.....	5	7.2 Cleaning The Lint Filter	25
1.3 General Safety	6	7.3 Cleaning The Dispenser	26
1.4 Installation	6	7.4 Cleaning The Drawer Recess ..	26
1.5 Use.....	7	7.5 Cleaning The Water Inlet Filter ..	26
2. PRODUCT DESCRIPTION	8	7.6 Cleaning Your Washing Machine.....	27
2.1 Parts.....	8	7.7 Cleaning Stains In The Washbowl.....	27
2.2 Product Features.....	10	8. TROUBLESHOOTING.....	28
3. CONTROL PANEL	11	8.1 Possible Failures.....	28
3.1 Control Panel Description	11	8.2 Troubleshooting Fault Displays..	30
3.2 Program Chart.....	12	8.3 Yellowing Or Greying Clothes ..	32
3.3 Program Options Compatibility..	13	9. TECHNICAL DATA.....	33
3.4 Options.....	14	10. INSTALLATION	34
3.5 Settings	16	10.1 Unpacking	34
4. DAILY USE	17	10.2 Positioning.....	36
4.1 Starting Your Washing Machine	17	10.3 Water Inlet.....	36
4.2 Load The Washing Machine....	17	10.4 Water Drainage	37
4.3 Add The Detergent/Bleach	17	10.5 Electrical Connection	38
4.4 Add Fabric Softener	18	11. ENVIRONMENT CONCERNS ..	39
4.5 Adding Bleach (Option)	18	11.1 Packaging Materials	39
4.6 Setting a Program	19	11.2 Old Machine	39
4.7 Starting a Program	19	11.3 Ecological Hints.....	39
4.8 Interruption Of A Program	19	WARRANTY	43
4.9 Changing A Program	19		
4.10 Changing The Options	19		
4.11 At The End Of The Program ..	20		
5. WASHING HINTS	21		
5.1 Sort Your Washing Into Separate Wash Loads.....	21		
5.2 Pre-treatment Sprays And Stain Removers	22		
5.3 Detergent	22		
5.4 A Guide To Stain Removal.....	22		
6. INTERNATIONAL WASH CODE SYMBOLS.....	24		

1. SAFETY INFORMATION

1.1 Conditions Of Use

This appliance is intended to be used in household and similar applications such as:

- staff kitchen areas in shops, offices and other working environment;
- farm houses;
- by clients in hotels, motels, and other residential type environment;
- bed and breakfast type environments;
- areas for communal use in blocks of flats or in laundrettes.

 **WARNING!** The appliance must not be supplied through an external switching device, such as timer, or connected to a circuit that is regularly switched on and off by utility.

In the interest of your safety and to ensure the correct use, before installing and first using the appliance, read this user manual carefully, including its hints and warnings.

To avoid unnecessary mistakes and accidents, it is important to ensure that all people using the appliance are thoroughly familiar with its operation and safety features.

 **WARNING!** If damage occurs to Door/Lid DO NOT OPERATE appliance while Door/Lid is missing or faulty. Please contact qualified technician to rectify.

Save these instructions and make sure that they remain with the appliance if it is moved or sold, so that everyone using it through its life will be properly informed on appliance use and safety.

1.2 Child Safety

- This appliance is not intended for use by young children or infirm persons without supervision.
- Young children should be supervised to ensure that they do not play with the appliance.
- The packaging components (e.g. plastic film, polystyrene) can be dangerous to children - danger of suffocation! Keep them out of children's reach.
- Keep all detergents in a safe place out of children's reach.
- Make sure that children or pets do not climb into the drum.
- This machine is provided with child safety lock option () to prevent children playing with the control panel. (see page 16)

1.3 General Safety

- It is dangerous to alter the specifications or attempt to modify this product in anyway.

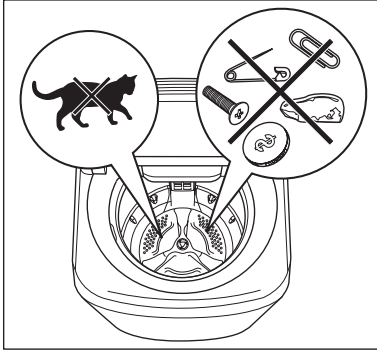

- Make sure that small pets do not climb into the washbowl. To avoid this, please check into the washbowl before using the appliance.
- Any objects such as coins, safety pins, nails, screws, hairpin, toothpick, stones or any other hard, sharp material can cause extensive damage and must not be placed into the machine.
- Only use the advised quantities of fabric softener and detergent. Damage to the fabric can ensue if you overfill. Refer to the manufacturer's recommendations of quantities.
- This appliance is not intended for use by persons (including children) with reduced physical, sensory or mental capabilities, or lack of experience and knowledge, unless they have been given supervision or instruction concerning use of the appliance by a person responsible for their safety.
- Wash small items such as socks, laces, washable belts etc in a washing bag or pillowcase as it is possible for such items to slip down between the tub and the agitator.

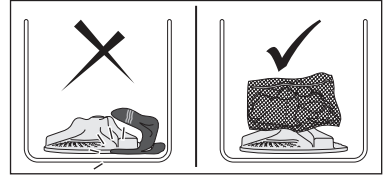

- Do not use your washing machine to wash articles with whale bones, material without hems or torn material.
- Always unplug the appliance and turn off the water supply after use, clean and maintenance.
- Under no circumstances should you attempt to repair the machine yourself. Repairs carried out by inexperienced persons may cause injury or serious malfunctioning. Contact your local Service Centre. Always insist on genuine spare parts.
- If the supply cord is damaged, should the appliance power supply cable need to be replaced, this shall be carried out by our Service Centre.

1.4 Installation

- When unpacking the appliance, check that it is not damaged. If in doubt, do not use it and contact the Service Centre.
- The appliance should not be installed in a humid place. The machine should be installed indoors without touching the rain.
- After having installed the appliance, check that it is not standing on the inlet and drain hose.
- If the machine is situated on a carpeted floor, please adjust the feet in order to allow air to circulate freely.
- Always be sure that there is no water leakage from hoses and their connections after the installation.
- Any plumbing work required to install this appliance should be carried out by a qualified plumber.
- Any electrical work required to install this appliance should be carried out by a qualified electrician.

- Make sure that the drainage is working properly.

! **May cause electric shock! if the machine is not connected to an earthed/ground system. DO NOT touch the wet clothes and metal parts.**

! **For safety reasons do not use double adaptors, extension cords and multi-plug adapters.**



- Water pressures between minimum 0.08 MPa and maximum 0.8 MPa are acceptable.

1.5 Use

- This appliance is designed for domestic use. It must not be used for purposes other than those for which it was designed.
- Only wash fabrics which are designed to be machine washed. Follow the instructions on each garment label.
- Do not overload the appliance. See the relevant section in the user manual.
- Before washing, ensure that all pockets are empty, and buttons and zips are fastened. Avoid washing frayed or torn articles and treat stains such as paint, ink, rust, and grass before washing.
- Garments which have been in contact with volatile petroleum products should not be machine washed. If volatile cleaning fluids are used, care should be taken to ensure that the fluid is removed from the garment before placing in the machine.

- Never pull the power supply cable to remove the plug from the socket, always take hold of the plug itself.

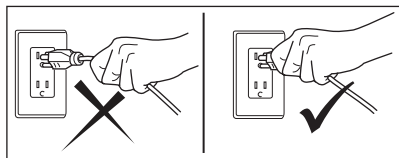

- Never use the Top-load Washing Machine if the power supply cable, the control panel, the working surface or the base are damaged so that the inside of the Top-load Washing Machine is accessible.

! **Components in the machine are designed to be used with water not hotter than 60 °C.**

! **Do not touch the power plug while your hand is still wet.**

! **Do not put your hand, foot, or anything under the washing machine while the machine is operated.**

2. PRODUCT DESCRIPTION

2.1 Parts

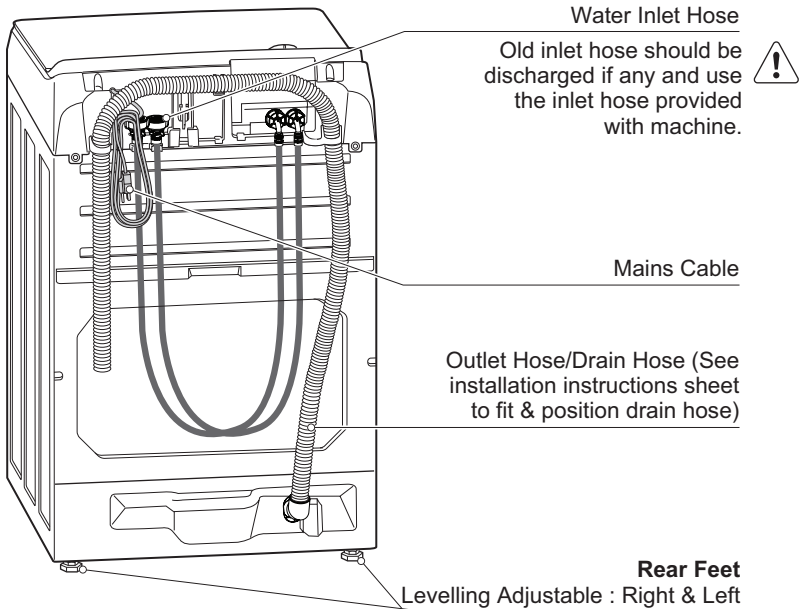
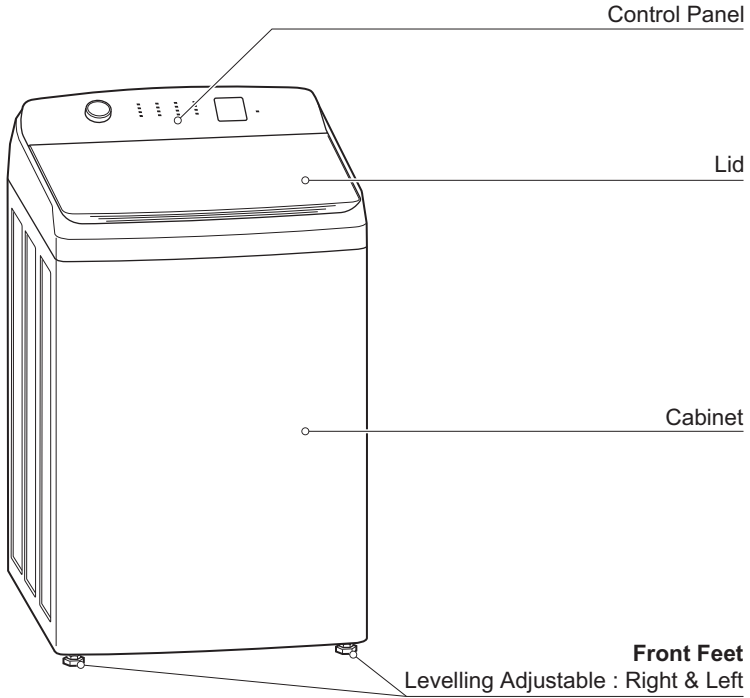

Detergent / Bleach Dispenser (see page 17)

Softener Dispenser (see page 18)

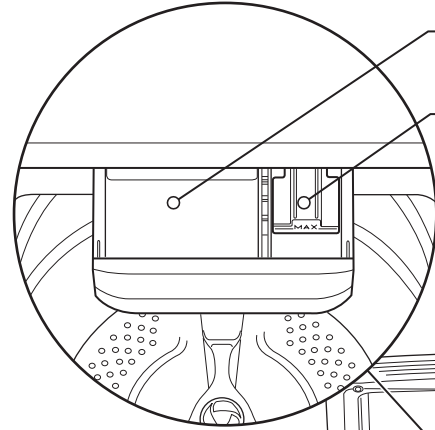

Bleach Dispenser (option)

Lint Filter (see page 25)

Low Profile Agitator

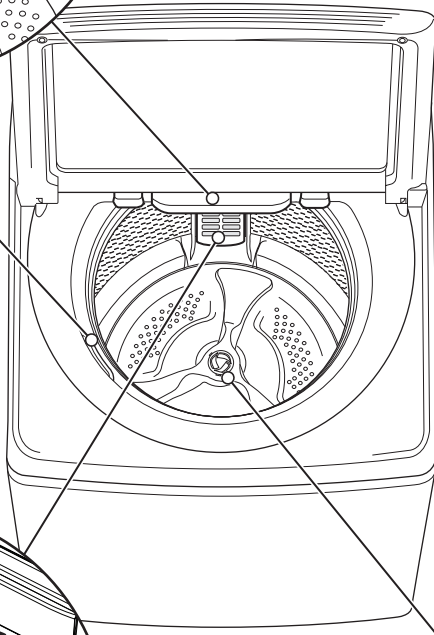
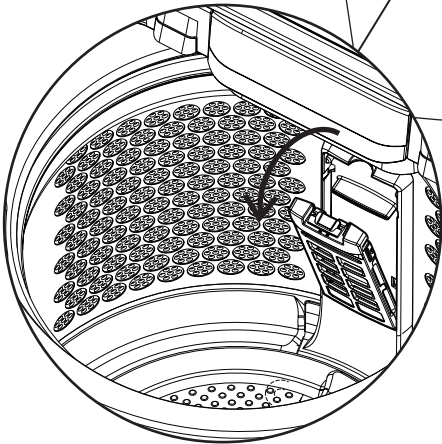

2.2 Product Features

Auto sensing water level

Auto sensing is a feature where the washer fills automatically with water to just the right level for your clothes load.

You do have the option to manually set the water level if you wish.

We recommend you use the auto sensing water level option to ensure there is just the right amount of water for the wash load in the machine. In other words, it will usually give you the best wash while also being the most efficient in terms of water usage.

At times during a wash, it may appear your machine is either doing nothing or intermittently it is only gently vibrating/jiggling/agitating.

This is because your machine could be:

- In auto sensing test mode and the machine is determining the correct amount of water for your wash.
- At a drain stage of the wash program and the machine is allowing time for water to flow the washbowl from to the out bowl.
- Engaging or disengaging the drive clutch mechanism. Wait a short time, your washing machine will complete the above tasks and continue with the wash.

Power Failure Recovery

When there is power failure while the machine is washing or rinsing or spinning. The machine tries to save the settings at which stage the machine is doing and then when the power returns back the machine will start washing from the stage where it is left off.

PreMix

This feature helps to dissolve and activate the active ingredients of the detergent, by blending the detergent with the water (except Fast 20 program), before dispensing into the tub and onto the clothes.

Dual Jets System

Dual jets help to improve cleaning results by spraying directly on the clothes and give a more thorough rinse-out of stains and dirt.

3. CONTROL PANEL

3.1 Control Panel Description

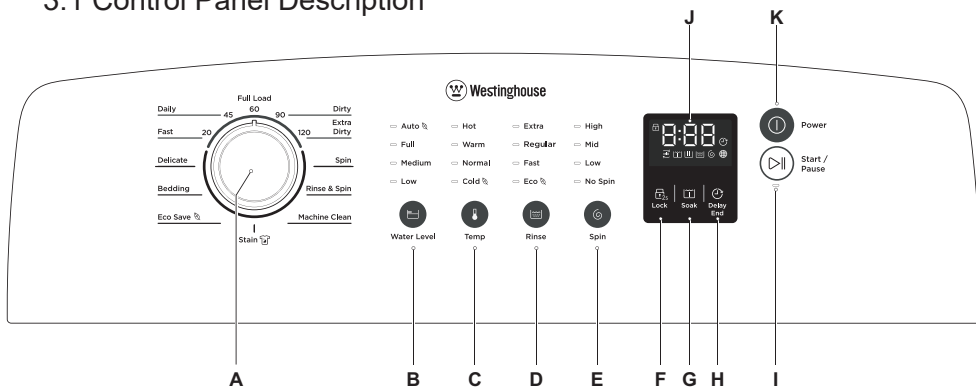

- A** Program selector knob
- B** Water Level touchpad
- C** Temp touchpad
- D** Rinse touchpad
- E** Spin touchpad
- F** Child safety lock option (press and hold touchpad about 2 seconds)
- G** Soak touchpad
- H** Delay End touchpad
- I** Start/ Pause touchpad
- J** Display
- K** Power touchpad

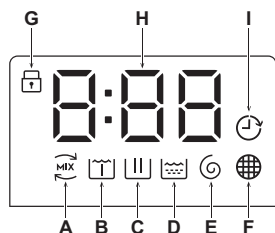

i Press the touch buttons with your finger in the area with the symbol.
Do not wear gloves when you operate the control panel.
Make sure that the control panel is always clean and dry.

Display



- A** PreMix Phase icon
- B** Soak Phase icon
- C** Wash Phase icon
- D** Rinse Phase icon
- E** Spin Phase icon
- F** Clean Filter Reminder icon
- G** Child safety lock option icon
- H** Program Duration / Delay End Time / Alarm Code
- I** Delay End icon

3.2 Program Chart

Program	Max. Load (Dry Clothes) ¹⁾				Type of load and soil level
	 Water Level				
	Auto	Full	Mid	Low	
Extra Dirty 120	Max ²⁾	Max	4 kg	2 kg	For heavily soiled cotton fabric.
Dirty 90	Max	Max	4 kg	2 kg	For moderately soiled cotton fabric.
Full Load 60	Max	Max	4 kg	2 kg	For normally soiled cotton fabric.
Daily 45	–	–	4 kg	2 kg	For normally soiled synthetic and mixed fabric.
Fast 20	–	–	–	2 kg	For lightly soiled synthetic and mixed fabric.
Delicate	4 kg	4 kg	2 kg	2 kg	Delicate fabrics such as acrylics, viscose, polyester items.
Bedding	4 kg	4 kg	2 kg	2 kg	For bedding fabrics labelled “Machine Washable”.
Eco Save  ³⁾	Max	Max	4 kg	2 kg	For normally soiled white and colourfast cotton. Set this program to have a good washing results and decrease the energy consumption.
Stain 	–	–	–	3 kg	This program helps to remove certain types of tough stains that are not easily removed by handwashing.
Machine Clean				No Load	Clean the tub.
Rinse & Spin	–	Max	4 kg	2 kg	For items that you want to rinse and spin e.g. Clothes items you have hand washed in a wash tub.
Spin				Maximum Capacity	For very wet clothes to remove the water.

1) Clothes Load depends on the Water level selected. For the best washing result, do not exceed the load weight over the suggestion as in the table above.

2) Maximum capacity depended on the model of the Washing Machine.

Model : WWT1284M7WA 12 kg

3) The energy label specification has been determined by using the following program according to AS/NZS 2040.

Eco Save, Normal temp, Full water level, No soak, Eco rinse, High spin speed.

3.3 Program Options Compatibility

Program	Option															Delay End					
	Water Level				Temp				Rinse				Spin				Soak				
	Auto	Full	Medium	Low	Hot	Warm	Normal	Cold	Extra	Regular	Fast	Eco	High	Mid	Low		No Spin	45 Mins.	30 Mins.	15 Mins.	No Soak
Extra Dirty 120	<input type="checkbox"/>	<input checked="" type="checkbox"/>	<input checked="" type="checkbox"/>	<input checked="" type="checkbox"/>	<input checked="" type="checkbox"/>	<input checked="" type="checkbox"/>	<input checked="" type="checkbox"/>	<input type="checkbox"/>	<input type="checkbox"/>	<input checked="" type="checkbox"/>	<input checked="" type="checkbox"/>	<input checked="" type="checkbox"/>	<input checked="" type="checkbox"/>	<input type="checkbox"/>	<input checked="" type="checkbox"/>	<input checked="" type="checkbox"/>	<input type="checkbox"/>	<input type="checkbox"/>	<input type="checkbox"/>	<input type="checkbox"/>	<input checked="" type="checkbox"/>
Dirty 90	<input type="checkbox"/>	<input checked="" type="checkbox"/>	<input checked="" type="checkbox"/>	<input checked="" type="checkbox"/>	<input checked="" type="checkbox"/>	<input checked="" type="checkbox"/>	<input checked="" type="checkbox"/>	<input type="checkbox"/>	<input type="checkbox"/>	<input type="checkbox"/>	<input type="checkbox"/>	<input type="checkbox"/>	<input checked="" type="checkbox"/>	<input checked="" type="checkbox"/>	<input checked="" type="checkbox"/>	<input checked="" type="checkbox"/>	<input type="checkbox"/>	<input type="checkbox"/>	<input type="checkbox"/>	<input type="checkbox"/>	<input checked="" type="checkbox"/>
Full Load 60	<input type="checkbox"/>	<input checked="" type="checkbox"/>	<input checked="" type="checkbox"/>	<input checked="" type="checkbox"/>	<input checked="" type="checkbox"/>	<input checked="" type="checkbox"/>	<input checked="" type="checkbox"/>	<input type="checkbox"/>	<input type="checkbox"/>	<input type="checkbox"/>	<input type="checkbox"/>	<input type="checkbox"/>	<input checked="" type="checkbox"/>	<input checked="" type="checkbox"/>	<input checked="" type="checkbox"/>	<input checked="" type="checkbox"/>	<input type="checkbox"/>	<input type="checkbox"/>	<input type="checkbox"/>	<input type="checkbox"/>	<input checked="" type="checkbox"/>
Daily 45			<input type="checkbox"/>	<input checked="" type="checkbox"/>	<input checked="" type="checkbox"/>	<input checked="" type="checkbox"/>	<input checked="" type="checkbox"/>	<input type="checkbox"/>	<input type="checkbox"/>	<input type="checkbox"/>	<input type="checkbox"/>	<input type="checkbox"/>	<input checked="" type="checkbox"/>	<input checked="" type="checkbox"/>	<input checked="" type="checkbox"/>	<input checked="" type="checkbox"/>	<input type="checkbox"/>	<input type="checkbox"/>	<input type="checkbox"/>	<input type="checkbox"/>	<input checked="" type="checkbox"/>
Fast 20				<input type="checkbox"/>	<input checked="" type="checkbox"/>	<input checked="" type="checkbox"/>	<input checked="" type="checkbox"/>	<input type="checkbox"/>	<input type="checkbox"/>	<input type="checkbox"/>	<input type="checkbox"/>	<input type="checkbox"/>	<input checked="" type="checkbox"/>	<input checked="" type="checkbox"/>	<input checked="" type="checkbox"/>	<input checked="" type="checkbox"/>	<input type="checkbox"/>	<input type="checkbox"/>	<input type="checkbox"/>	<input type="checkbox"/>	<input checked="" type="checkbox"/>
Delicate	<input type="checkbox"/>	<input checked="" type="checkbox"/>	<input checked="" type="checkbox"/>	<input checked="" type="checkbox"/>		<input checked="" type="checkbox"/>	<input checked="" type="checkbox"/>	<input type="checkbox"/>	<input checked="" type="checkbox"/>	<input type="checkbox"/>	<input checked="" type="checkbox"/>	<input checked="" type="checkbox"/>		<input checked="" type="checkbox"/>	<input type="checkbox"/>	<input checked="" type="checkbox"/>	<input checked="" type="checkbox"/>	<input checked="" type="checkbox"/>	<input checked="" type="checkbox"/>	<input type="checkbox"/>	<input checked="" type="checkbox"/>
Bedding		<input type="checkbox"/>	<input checked="" type="checkbox"/>		<input checked="" type="checkbox"/>	<input checked="" type="checkbox"/>	<input checked="" type="checkbox"/>	<input type="checkbox"/>	<input checked="" type="checkbox"/>	<input type="checkbox"/>			<input checked="" type="checkbox"/>	<input checked="" type="checkbox"/>	<input type="checkbox"/>	<input checked="" type="checkbox"/>	<input checked="" type="checkbox"/>	<input checked="" type="checkbox"/>	<input checked="" type="checkbox"/>	<input type="checkbox"/>	<input checked="" type="checkbox"/>
Eco Save 	<input checked="" type="checkbox"/>	<input type="checkbox"/>	<input checked="" type="checkbox"/>	<input checked="" type="checkbox"/>	<input checked="" type="checkbox"/>	<input checked="" type="checkbox"/>	<input type="checkbox"/>	<input checked="" type="checkbox"/>	<input checked="" type="checkbox"/>	<input checked="" type="checkbox"/>	<input type="checkbox"/>	<input type="checkbox"/>	<input checked="" type="checkbox"/>	<input checked="" type="checkbox"/>	<input checked="" type="checkbox"/>	<input checked="" type="checkbox"/>	<input checked="" type="checkbox"/>	<input checked="" type="checkbox"/>	<input checked="" type="checkbox"/>	<input type="checkbox"/>	<input checked="" type="checkbox"/>
Stain				<input type="checkbox"/>	<input type="checkbox"/>			<input checked="" type="checkbox"/>	<input type="checkbox"/>			<input type="checkbox"/>	<input checked="" type="checkbox"/>	<input checked="" type="checkbox"/>	<input checked="" type="checkbox"/>	<input checked="" type="checkbox"/>	<input type="checkbox"/>	<input type="checkbox"/>	<input type="checkbox"/>	<input type="checkbox"/>	<input checked="" type="checkbox"/>
Machine Clean																					
Rinse & Spin	<input type="checkbox"/>	<input checked="" type="checkbox"/>	<input checked="" type="checkbox"/>				<input type="checkbox"/>	<input checked="" type="checkbox"/>	<input type="checkbox"/>	<input checked="" type="checkbox"/>	<input checked="" type="checkbox"/>	<input type="checkbox"/>	<input checked="" type="checkbox"/>	<input checked="" type="checkbox"/>	<input checked="" type="checkbox"/>	<input type="checkbox"/>	<input type="checkbox"/>	<input type="checkbox"/>	<input type="checkbox"/>	<input type="checkbox"/>	<input type="checkbox"/>
Spin												<input type="checkbox"/>	<input checked="" type="checkbox"/>	<input checked="" type="checkbox"/>							

Remark

- Default option
- Available select option

3.4 Options

Water Level Touchpad

Choose the water level by pressing the “Water Level” touchpad.
 Use only the amount of water you need for the wash load.
 Please refer the to program table on page 12.

 Flood diagnostic is explained on page 30. You should refer to this if you have water pouring onto the floor. The display will show “E30” and you will hear rapid short beeps continuously to remind you about this problem.

Temp Touchpad

For each wash program your washing machine automatically selects a suitable fill water temperature. If you want to use a different wash water temperature, press the Temperature button repeatedly.

The water temp lights will tell you the temperature for each press of the button.

You have four temperatures to choose from Hot, Warm, Normal and Cold.

The temperature of warm water will depend on the temperature and pressure of your hot and cold water supplies. The recommended temperature for warm is 35°C.

You can adjust the flow rate of the water supplies to adjust the Warm temperature. All rinse water temperatures are cold.

Always check your label for the washing temperature symbols which the International Care Labelling Code now uses



 If you have a cold water connection ONLY and the hot inlet valve is capped off (refer installation instructions) **you must select Cold washes only.**

Water Temperature

Mixed water temperatures in table below are based on hot water supply of 60 °C and cold water supply of 20 °C

Hot & Cold water usage proportion			
Temp.	Hot Valve	Cold Valve	Temp after mixing water
Hot	75%	25%	50 to 55 °C
Warm	40%	60%	35 to 40 °C
Normal	10%	90%	20 to 25 °C
Cold	0%	100%	

 Components in the washing machine are designed to be used with water no hotter than 60°C. If your water supply is too hot, you should have a temperature limiting valve fitted by a qualified plumber.

Rinse Touchpad

Pressing the Rinse touchpad to choose the rinse type for your wash load. For most washes, the machine automatically fills the full tub of water for a rinse.

There are four rinses to choose from Extra, Regular, Fast and Eco to remove the detergent from the clothes.

- **Extra rinse** - 2 rinses cycles
- **Regular rinse** - 1 rinse cycle
- **Fast rinse** - Spraying water 3 rinses cycles.
- **Eco** - Spraying water 4 rinses cycles.

How does Eco Rinse work?

When Eco rinse is used, rinse water is sprayed into the washbowl in pulses. After each pulse the washbowl will spin to remove detergent laden water from the clothes.

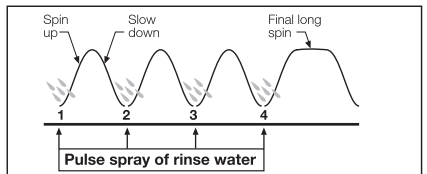

The machine will go through a series of maximum 4 pulses spray and short spin cycles in this manner, depending on program selection, followed by a final long spin that removes the water from the clothes to complete the full wash program.

Note:

- Compare this with Regular rinse where much more water is used.
- Regular rinse, water enters the machine filling up to the wash water level selected. The washer agitates and finally empties the rinse water through the drain hose.
- Extra rinse, this is a special option for those people who suffer from allergies, this extra rinse will provide 2 rinses to ensure all detergent residue has been removed.
- Eco and Fast rinse is not designed to be used with fabric softener.
- Select Regular rinse if you are going to use fabric softener.
- Regular rinse ensures the fabric softener is correctly dispensed and thoroughly removed from your clothes during rinsing.

Spin Touchpad

Press this touchpad to select the spin speed or no spin, if you want your laundry to be spun at a speed different from the one proposed by the washing machine.

The speed of spin level are:

- **High**, about 800 rpm ;
- **Mid**, about 650 rpm ;
- **Low**, about 550 rpm.
- **No Spin**, 0 rpm.

Soak Touchpad

This option allows you to soak heavily soiled clothes at the beginning of the wash. To do this, press the Soak touchpad to select the soak time.

The lid must be closed to allow Soak functions to operate. The machine will agitate for short periods. At other times, the clothes are soaking and the machine will be doing nothing.

Delay End Touchpad

Before you start the program, this option makes it possible to define the end of the washing program from minimum of 1 hour to maximum of 20 hours.

Press the Delay End touchpad to choose the end time as you wish. The display shows the number of hours.

 This option must be selected after choosing the wash program, and before pressing the “Start/Pause” touchpad.

For example, if the program duration of your selected program is 3.20 hours and you define the “Delay End” time to 6 hours. This means your wash program will finish in 6 hours. (See diagram)

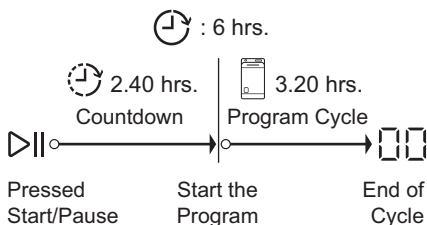

After selecting Delay End time, press Start/Pause touchpad to start the program. Machine will then countdown and update time on the display every hour until it reaches the starting point of the wash cycle.

If you wish to modify or cancel Delay End option after starting the program, follow the steps below:



- set the washing machine to PAUSE by pressing “Start/Pause” touchpad;
- deselect this option by pressing “Delay End” touchpad repeatedly till the display shows delay time “  ”;
- press the “Start/Pause” to start the program.

Start/Pause Touchpad

To start the selected program, press the “Start/Pause” touchpad.

If you have started your wash and you wish to stop it for some reason, press the “Start/Pause” touchpad to enter PAUSE mode

To restart the program from the point at which it was interrupted, press the “Start/Pause” again.

 If the lid is opened during operation, the machine will go into PAUSE mode and display show “ ”.

After closing the lid press Start/Pause touchpad on the control panel to restart the program.





3.5 Settings

Child Safety Lock () Option

Your appliance is provided with CHILD SAFETY LOCK which permits you to leave the appliance unsupervised with the door closed without having to worry that children might be injured by or cause damage to the appliance.

 Set this option AFTER pressing the Start/Pause touchpad.



To set “Child Lock” option:

- To activate the function, press and hold “Lock  ” touchpad about 2 seconds until the display shows the icon “ ”.
 -  – If you press any touchpad while Child Lock is activated, the icon “ ” will flash on display 3 times along with buzzer sound.
 - **All the touchpads are locked.** You must deactivate the function before operating the washing machine.
- To deactivate the function, press and hold this touchpad again until the icon “ ” in the display disappears.

Enabling/Disabling End-Of-Wash Buzzer

This setting permits you to either enable or disable the buzzer at the end of the program. As an example, you might wish to disable this buzzer when you start a wash when going to bed, so that when the wash finishes approximately 1 hour later, it will not disturb you through the night.

 Error warning beeps such as critical faults are not disabled.

- To disable the buzzer sound, press “Water Level” and “Temp” touchpads at the same time about 3 seconds, the icon “ ” will show on display along with buzzer sound.
- To return to default configuration press these two touchpads at the same time about 3 seconds, the icon “ ” will show on display along with buzzer sound.

4. DAILY USE

4.1 Starting Your Washing Machine

1. Connect the mains plug to the mains socket.
2. Turn the water tap on.

4.2 Load The Washing Machine

When loading the clothes into your washing machine, there are four things to remember:

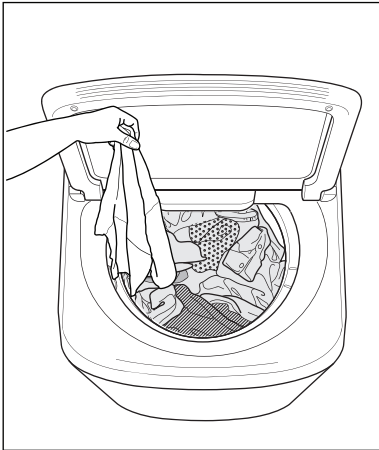

1. Clothes must be loaded evenly around the agitator. For best results, load small items first, followed by large items.
2. Clothes must not be wrapped around the tub.
3. The washing machine must not be overloaded. Clothes must be able to move during wash.
4. The load should contain only three or four large items, for example sheets. The rest of the load should be small items. A mixed load of large and small items will wash cleaner than a load of all large items.

4.3 Add The Detergent/Bleach

Powder / Liquid Detergent / Bleach

1. Pull the dispenser drawer forward out from its position.

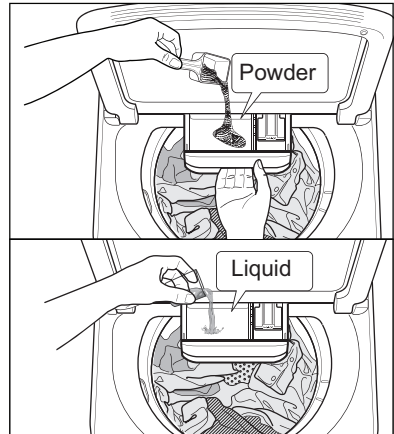

2. Measure the correct amount of powder or liquid detergent by following the recommendations on the package.
3. Pour it into the detergent dispenser drawer.
4. Put the dispenser back into its recess.

Liquid Detergent (Option)

Pouring onto the clothes.

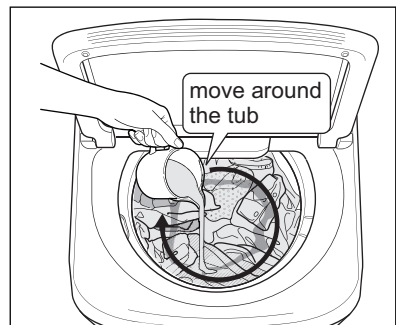

1. Measure the correct amount of liquid detergent by following the recommendations on the package.

- Mix detergent in one litre of water.
- Add the pre-mixed detergent to the wash load.

i NOTE: When you use the liquid detergent

- Do not use gelatinous or thick liquid detergents.

4.4 Add Fabric Softener

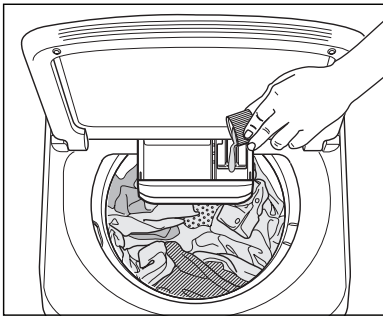

1. Measure the correct amount of fabric softener by following the recommendations on the package.
2. Mix softener with an equal amount of warm water but only mix enough to fill to the line marked inside the cup. The softener cup holds 75ml.
3. Pour the mixed softener into the cup on the top of the agitator. Do not overfill the cup.



Do not spill fabric softener on the clothes as it may stain them.

i NOTE

- The softener amount used must not exceed the "MAX" mark in the cup.
- If you use thick softeners it is recommended to dilute with water.
- Residues of softener and water may remain in the cup. It is recommended to clean the cup regularly to remove any residue.
- The softener unable used with Eco and Fast rinse.

4.5 Adding Bleach (Option)

Bleaching of clothes can help to remove stains, heavy soiling and to kill bacteria.

Oxygen Type

This is generally a powder type bleach. Pour it into the detergent dispenser drawer or mix the required quantity with water and pour down the bleach hole in the top of the washing tub during the fill when there is some water in the washbowl.

Chlorine Type

This type of bleach should not be mixed with detergent. Mix the bleach with water as per the instructions on the container.

How to soak with bleach, proceed as follows:

1. Turn Program Selector to a **Full Load 60** position.
2. Press the Start/Pause button to commence water fill.
3. Pour the bleach solution down the hole in the top of washing tub during fill when there is some water in the washbowl by tilting the washing tub as picture below.

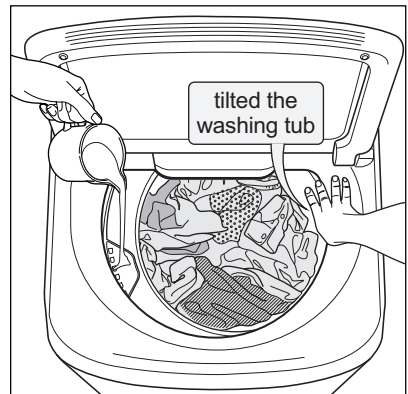

4. Allow the machine to agitate for a few minutes, then let it stand for the required time by pressing Start/Pause touchpad to pause the machine.
5. When soaking bleach reached the required time, turn Program Selector to Rinse & Spin position and press the Start/Pause touchpad to empty the washbowl.

4.6 Setting a Program

1. Press Power (ⓘ) touchpad, turn the program selector to the required program.
 - Your washing machine is now in STAND-BY-MODE and ready to wash your clothes.
 - The relevant light will light up.
 - The buzzer will sound.
 - The selector dial can be turned either clockwise or anticlockwise.
 - Once you select a program, the program selected will stay at that position for the whole of the cycle.
 - The display shows the program duration.

If the settings shown on the control panel are what you want to use, press the Start/Pause touchpad to start your wash.

2. If you want your laundry to be washed with functions different from the one proposed by the machine, press Water Level, Soak, Rinse and Spin option touchpads.

NOTE:

Different functions can be combined which is dependent on the program selected. When these touchpads are pressed, the corresponding pilot lights come on.

3. If you want to define the end of the washing program, press the "Delay End" touchpad repeatedly to choose your machine end time.

4.7 Starting a Program

To start a program, press the Start/Pause (▷||) touchpad, a default program duration will be displayed on the screen.

NOTE

When you select the Rinse & Spin program, there will be a delay of at least 2 minutes before the washing machine starts to spin.

This delay is a drain out period to ensure the bowl is empty of water, which is necessary before spin commences. Even though you may have only put wet clothes into an empty bowl, the delay before spin will still occur to be safe and to protect your washing machine.

4.8 Interruption Of A Program

If you have started your wash and you wish to stop it for some reason, press the Start/Pause touchpad to enter PAUSE mode.

The time remaining is blink and the Start/Pause LED will start flashing. Press the Start/Pause again. The program will continue.

4.9 Changing A Program

Changing a running program **is possible only by switching off** the appliance.

- Press the "Power" touchpad to cancel the program and to turn off the appliance.
- Press the "Power" touchpad again to start the appliance.

Now you can set a new wash program and change any available options. Press Start/Pause to start the new program.

4.10 Changing The Options

It is possible to change only some options after the program has started.

1. Press the Start/Pause touchpad to enter PAUSE mode.
2. Change the options.
3. Press Start/Pause touchpad again. The program will continue.

4.11 At The End Of The Program

- The appliance stops automatically.
- The display will show “End” and flashing with 3 consecutive long beeps.
- Press Power touchpad to turn off the machine.
- Remove the laundry from the appliance. Make sure that the washing tub is empty.
- Keep the lid ajar, to prevent the mildew and odours.
- Turn off the water tap.

NOTE

When indicator “” appears and blinks after the appropriate number of wash cycles are finished, this indicator is reminds you to clean the lint filters.

Refer to “Cleaning The Lint Filter” on page 25

5. WASHING HINTS

These Washing Instructions are of a general nature and you should get good wash results by following them.

However, due to the variables of fabric types, soil levels, detergent types and available program settings you may find some combinations of these which do not always result in the perfect wash.

If for example you see residuals of detergent or soils on some items, please read the section Residues on washed items paragraph.

Over time you will learn what is the best set-up of programs, detergent and load sorting for different load types and soils.

5.1 Sort Your Washing Into Separate Wash Loads



- Each load of washing should contain clothing which needs the same washing conditions. For example, you should not wash delicate clothes with very dirty work clothes.
- Colour fast and non-colourfast fabrics should be separated. Knowing the type of fabrics you have and how dirty they are will help when you make selections from the wash program options.
- Some fabrics are lint collectors and can pick up lint, dirt and colour from other fabrics which are lint producers. Some examples are listed below:

Lint collectors	Lint producers
- Corduroy	- Towels
- Synthetics	- Nappies
- Permanent press fabrics	- Chenille/Candlewick

i NOTE:

Make sure that you wash lint collectors separately from lint producers.

- Never wash whites and coloureds together. Whites may lose their “whiteness” in the wash.
- New coloured items may run in the first wash; they should therefore be washed separately the first time.

! IMPORTANT!

- Make sure that no metal objects are left in the laundry (e.g. hair clips, safety pins, pins).
- Button up pillowcases, close zip fasteners, hooks and poppers.

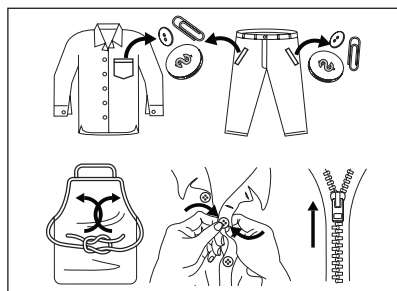

- Tie any belts or long tapes.
- Remove persistent stains before washing.
- Rub particularly soiled areas with a special detergent or detergent paste.
- Treat curtains with special care.
- Wash bras, pantyhose and other delicates in a mesh laundry bag, which you can purchase from your supermarket.

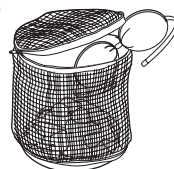

- Remove hooks or tie them up in a bag or net.

5.2 Pre-treatment Sprays And Stain Removers



WARNING!

Pre-treatment sprays and stain remover can damage plastic components on your washing machine.

If you use pre-treatment sprays or stain removers, apply them to the clothing well away from your washing machine.

5.3 Detergent

Good washing results also depend on the choice of detergent and use of the correct quantities to avoid waste and protect the environment.

Although biodegradable, detergents contain substances which, in large quantities, can upset the delicate balance of nature.

The choice of detergent will depend on the type of fabric (delicates, woollens, cottons, etc.), the colour, washing temperature and degree of soiling.

- Don't use the wrong type of detergent. You must use a low sudsing detergent designed for front load washing machines or high efficiency top loaders, such as Cold Power for Front Loaders and High Efficiency Top Loaders or detergents labelled "Matic".
- Don't use soap-based products in your washing machine.
- Don't use too much detergent. This can result in excessive suds that can cause low spin speeds, poor rinsing and overloading the motor during spin stages of the wash program.
- Don't use too little detergent because you will get a poor wash. If you think you need more, increase dosages by only small amounts to avoid excessive suds.

Quantity of detergent to be used

The type and quantity of detergent will depend on the type of fabric, load size, degree of soiling and hardness of the water used.

Water hardness is classified in so-called "degrees" of hardness.

Information on the hardness of the water in your area can be obtained from the relevant water supply company, or from your local authority.

Follow the product manufacturers' instructions on quantities to use.

- Not enough washing powder causes: the wash load to turn grey, greasy clothes.
- Too much washing powder causes: sudsing, reduced washing effect, inadequate rinsing.
- Use less detergent if: you are washing a small load, the laundry is lightly soiled, and large amounts of foam form during washing.

5.4 A Guide To Stain Removal

Stubborn stains may not be removed by just water and detergent. It is therefore advisable to treat them prior to washing.

Blood, Meat Juice, Egg: treat fresh stains with cold water. For dried stains, soak overnight in water with a special detergent then rub in the soap and water.

- Dry Stain: cover the area with a meat tenderizer (msg). Apply warm water to make a paste. Wait 15-20 minutes. Sponge with cool water or with diluted bleach.
- Fresh Stain: rinse in cold water. If stain remains, sprinkle with a meat tenderizer (msg). Let stand for 15-20 minutes. If the stain still remains, then sponge with diluted bleach. Wash using hot water.

Chocolate: soak in warm water with the pre-soak product, and wash in lukewarm water. Use dry cleaning quid (white spirits) to remove any grease spots.

Coffee/Tea (Milk or Cream): rinse or soak in cold water. Work detergent into stain. Thoroughly rinse and dry. If a stain remains, sponge with dry cleaning quid. If the stain remains, bleach.

Coffee/Tea (Black), Fruit Juice, White Wine: pour boiling water through the stain. Bleach if necessary.

Oil based paint: moisten with benzine stain remover, lay the garment on a soft cloth and dab the stain; treat several times.

Dried grease stains: moisten with turpentine, lay the garment on a soft surface, and dab the stain with the fingertips and a cotton cloth.

Rust: oxalic acid dissolved in hot water or a rust-removing product used in cold water. Be careful with rust stains that are not recent since the cellulose structure will already have been damaged and the fabric tends to hole.

Mould stains: treat with bleach, rinse well (whites and fast coloureds only).

Grass: soap lightly and treat with bleach (whites and fast coloureds only).

Ball-point pen and glue: moisten with acetone (*), lay the garment on a soft cloth and dab the stain.

Lipstick: moisten with acetone (*) as above, then treat stains with methylated spirits. Remove any residual marks from white fabrics with bleach.

Red wine: soak in water and detergent, rinse and treat with acetic or citric acid, then rinse. Treat any residual marks with bleach.

































Ink: depending on the type of ink, moisten the fabric first with acetone (*), then with acetic acid; treat any residual marks on white fabrics with bleach and then rinse thoroughly.

Tar stains: first treat with stain remover, methylated spirits, or benzine, then rub with detergent paste.

(*) do not use acetone on artificial silk.

6. INTERNATIONAL WASH CODE SYMBOLS

i These symbols appear on fabric labels, in order to help you choose the best way to treat your laundry.

 Energetic wash  Delicate wash	 Max. wash temperature 95 °C	 Max. wash temperature 60 °C 	 Max. wash temperature 40 °C  	 Max. wash temperature 30 °C 	 Hand wash	 DO NOT wash at all
 Bleaching	 Bleach in cold water			 DO NOT bleach		
 Ironing	 Hot iron max. 200 °C	 Warm iron max. 150 °C	 Lukewarm iron max. 110 °C	 DO NOT iron		
 Dry cleaning	 Dry cleaning in all solvents	 Dry cleaning in perchloroethylene, petrol, pure alcohol, R 111 & R 113	 Dry cleaning in petrol, pure alcohol and R 113	 DO NOT dry clean		
 Drying	 Flat	 On the line	 On clothes hanger	 High temperature  Low temperature Tumble dry	 DO NOT tumble dry	

7. CARE AND CLEANING

Your washing machine will give you long and trouble-free service, if you follow the instructions in this section. These instructions show you how to care for your washing machine.

7.1 What To Do After You Have Finished Your Washing.

1. Press the Power button to turn off the machine.
2. Switch off the electricity at the power point.
3. Turn off the water taps. This will extend the life of the inlet hoses.
4. Leave the lid open for a while. This allows time for moisture inside the washing machine to evaporate and for any odours to disperse.

7.2 Cleaning The Lint Filter

Lint is a collection of threads and fluff which comes off your clothes during washing. Your washing machine collects this lint in the lint filter. It is important to clean out this lint filter preferably after each wash.

How to clean the lint filter:

1. Remove the filter from the washing tub.

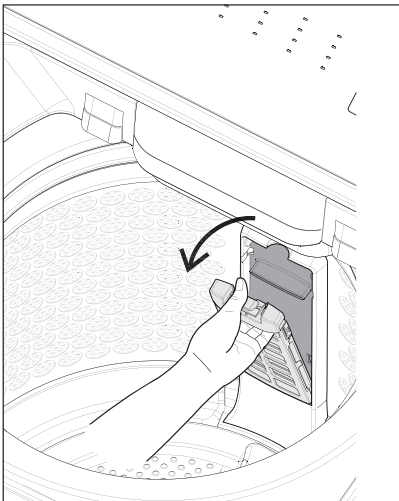

2. Unclip the filter as the picture.

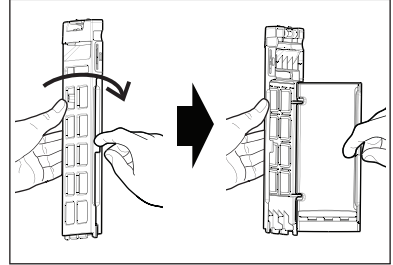

3. Clean the filter under a tap with a stiff brush to remove any lint.

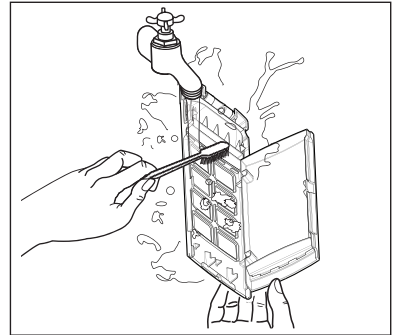

4. Reassemble the filter to the housing.

7.3 Cleaning The Dispenser

The dispenser needs to be cleaned regularly, preferably after each wash. Inspect the dispenser after each wash to see if there is any residue of detergent.

To do this proceed as follows:

1. Remove the dispenser drawer from its places.

Pull out the dispenser drawer until it stops then lift up and pull out from the recess.

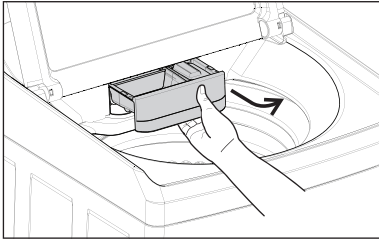

2. Clean the dispenser drawer with water and a brush, e.g. an old toothbrush.

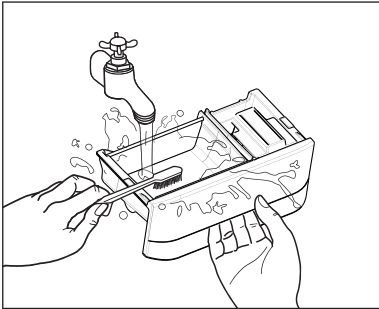

3. Dry the drawer.

7.4 Cleaning The Drawer Recess

Having removed the drawer, use a small brush to clean the recess, ensuring that all washing powder residue is removed from the upper and lower part of the recess. Replace the drawer and run the rinse program without any clothes in the drum.

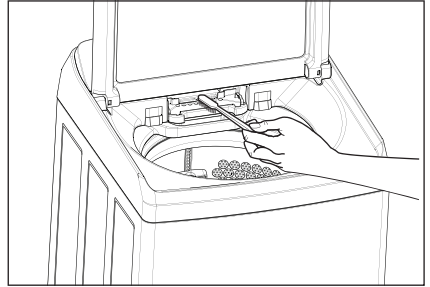

7.5 Cleaning The Water Inlet Filter

If your water is very hard or contains traces of lime deposit, the water inlet filter may become clogged. It is therefore a good idea to clean it from time to time.

To clean the water inlet filters:

1. Close the water tap.
2. Remove the water inlet hose from the water tap.
3. Clean the filter in the inlet hose with a stiff brush.

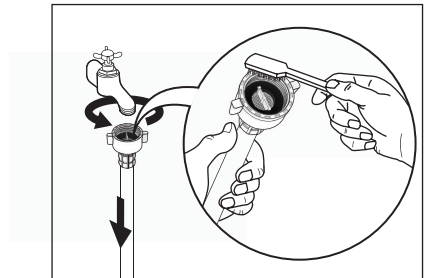

- Remove the inlet hose behind the appliance.

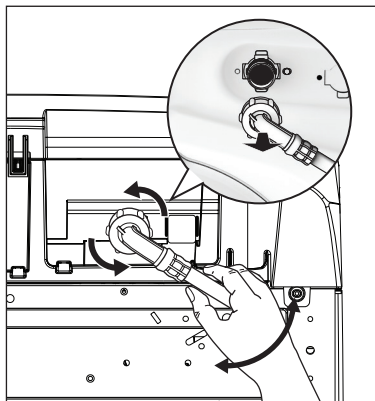

- Clean the filter in the valve with a stiff brush or a towel.

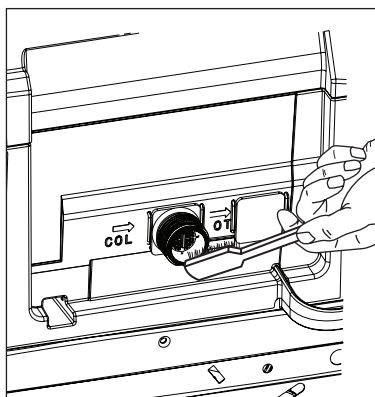

- Install the inlet hose again. Make sure that the couplings are tight to prevent leakages.
- Open the water tap.

7.6 Cleaning Your Washing Machine

To clean the inside and outside of your washing machine you should:

- Wipe the surface with warm water.
- Wipe dry with a soft cloth.

i Important:

Never use solvents, alcohol, aerosol cleaners, spray pack cleaners, glass cleaners, metal polishes, caustic materials, scourers or general household cleaners on or near the top panel and lid, control panel or other parts of your washing machine.

7.7 Cleaning Stains In The Washbowl

Stains in the wash bowl can be caused by:

- metal objects such as bobby pins, dressmaking pins and nails;
- salt;
- body oils and grease from very dirty or sweaty clothes being deposited around the top of the washbowl;
- excessive foam during wash if incorrect or too much detergent is used.

i Important:

Check all pockets before loading clothes into your washing machine.

Don't leave wet clothing (especially swimwear) in the bowl for too long before you wash it.

How To Clean the Stainless Steel Wash Bowl :

- Wipe with a cleaning product which is marked suitable for stainless steel.
- Oily deposits can be removed by wiping surfaces with a mild dishwashing detergent and warm water.

i Important:

Never use bleach cleaners or steel wool to clean the stainless steel washbowl.

8. TROUBLESHOOTING

8.1 Possible Failures

DO NOT call for service until you have checked the points listed below.

If you call for service and there is nothing wrong with your washing machine, you will have to pay for the service call.

You will have to pay even when your washing machine is under warranty. Before you call for service, check the points in the table below.

If after all checks, the problem persists, contact your local Service Centre.

Problem	Display Code	Possible Causes	What to do
Machine not working.		Power not switched on.	Switch on power point.
		No electricity supply through the power point.	Check the power point with another appliance.
	E10	Water taps not turned on.	Turn on taps.
	EFO	Out of balance switch off.	Open lid, redistribute load and close lid.
	Ld	Lid not fully closed.	Close lid and press Start/Pause to resume operation.
	EHO	The main supply is unstable.	Wait until the main supply is stable and the appliance automatically starts operating.
Machine has washed load but will not spin.	EFO	Out of balance.	Open lid, redistribute load, close lid.
	Ld	Lid not fully closed.	Close lid and press Start/Pause to resume operation.
Water in wash bowl.	E20	Drain hose blocked.	Check drain hose for blockage. Wait a short while, the wash will continue.
Will not fill with water.	E10	Water taps not turned on.	Turn taps on.
		Inlet hoses blocked.	Clean tap filters/washers.
Machine goes out of balance or vibrates excessively when spinning.	EFO	Machine not level.	Make the machine level.
		Levelling feet not adjusted.	Adjust feet to touch the floor.
		Clothes not evenly distributed.	Redistribute clothes evenly.
Water on floor.		Loose inlet hose connections.	Check connections at taps and rear of machine.
		Loose drain hose connections.	Check connections at rear of machine.

Problem	Display Code	Possible Causes	What to do
Clothes still dirty after wash program.		Not enough or no detergent.	Check detergent use and rewash clothes.
		Too many clothes on load.	Remove some clothes and rewash.
		Incorrect wash program.	Reselect program and rewash.
Scraping noise on spin.		Bra wire or other thin items caught between inner and outer washbowls.	If the item is visible, remove it with pliers. Use a wash bag in future.
Humming, clicking and other noises.		Bowl rotation at start of wash.	Normal noise.
		Brake activation when stopping after spin.	Normal noise.
Door/Lid glass damaged or abnormal position		Transportation or unexpected damage	 DO NOT OPERATE while in this condition. Contact Service provider to rectify.

8.2 Troubleshooting Fault Displays

When the washing machine detects a problem that requires your attention, you will be alerted. The machine will warn you of this problem by displaying a fault code in the digital display, accompanied by “Beeping”.

Error code and the possible fault information are described in the following table.

Display Code	Description	Possible fault
E10	Difficulties in water fill for washing	<ul style="list-style-type: none"> - Tap closed - Water flow too low - Water inlet valve defective - Machine system leaking - Drain hose installation wrong - Pressure sensor defective - Wiring or main board defective
	Water leakage	<ul style="list-style-type: none"> - Machine system leaking - Drain hose installation wrong - Pressure sensor defective
	Water tap	<ul style="list-style-type: none"> - Without connecting hot tap, only cold temperatures can be selected.
E20	Difficulties in draining for washing	<ul style="list-style-type: none"> - Drain system blocked up - Drain pump / Drain valve defective - Pressure sensor defective - Wiring or main Board defective
	Drain pump triac failure	<ul style="list-style-type: none"> - Drain pump defective - Wiring, connector or main board defective
E30	Pressure sensor faulty	<ul style="list-style-type: none"> - Pressure sensor defective - Wiring or main Board defective
	Pressure sensor calibration problems	<ul style="list-style-type: none"> - Water inlet valve defective - Pressure sensor defective - Drain system blocked up - Drain pump / Drain valve defective - Wiring or main board defective
	Water Overload	<ul style="list-style-type: none"> - Water inlet valve defective - Pressure sensor defective - Wiring or main board defective

Display Code	Description	Possible fault
E50	Motor system problems	<ul style="list-style-type: none"> - Motor defective - Motor Wiring or Motor Control board defective - Overload condition
E91	UI -MB communication error	<ul style="list-style-type: none"> - Wiring defective, or UI, MB board defective
EHO	Power supply frequency out of limits	<ul style="list-style-type: none"> - Wrong or disturbed Power Supply line. - Main board defective
	Power supply voltage too high	<ul style="list-style-type: none"> - Wrong or disturbed Power Supply line. - Main board defective
	Power supply voltage too low	<ul style="list-style-type: none"> - Wrong or disturbed Power Supply line. - Main board defective
ECO	Drive train triac failure (actuator)	<ul style="list-style-type: none"> - TY5 triac load device defective (drive train device) - Wiring or main board defective
EFO	Foam warning	<ul style="list-style-type: none"> - Excessive detergent dosing - Drain filter dirty or clogged - Drain pipe kinked or clogged
	Load too unbalanced	<ul style="list-style-type: none"> - Load unbalanced

8.3 Yellowing Or Greying Clothes

Problem	Possible causes	What to do
Greyness	<ul style="list-style-type: none"> • Incorrect wash times and using insufficient detergent which can cause redepositing of detergent on clothes. • Using incorrect type or too much detergent can cause poor rinsing and poor spin performance. • Mixing whites with very dirty clothes, e.g. work clothes. • Using soap flakes instead of laundry detergent. 	<ol style="list-style-type: none"> 1. ONLY use low sudsing, front load washer detergent in this machine, such as Cold Power for Front Loaders and High Efficiency Top Loaders or detergent labelled "Matic". 2. Re-sort load, then re-wash using program selections suitable for the fabric. 3. If the water is very dirty or very sudsy, repeat 2 above reducing the amount of detergent you use.
Yellowing	<ul style="list-style-type: none"> • A build-up of oils in clothes that come into close contact with the skin, e.g. underwear, T-shirts. • Ageing of clothes. Iron deposits in the wash water. • Use of chlorine bleaches on fabrics with resin finishes. • Incorrect drying. 	<ol style="list-style-type: none"> 1. Re-sort load, then re-wash using wash program selections suitable for the fabric. 2. If the water is very dirty or very sudsy, repeat 1 above reducing the amount of detergent you use.

9. TECHNICAL DATA

Dimensions (Height / Width / Depth)	1092 x 670 x 720 mm	
Power supply (Voltage / Frequency)	220 - 240 V~ / 50 Hz	
Total power absorbed	550 W	
Water supply pressure (Maximum / Minimum)	0.8 MPa / 0.08 MPa	
Maximum dry clothes capacity	Extra Dirty	120 Max
	Dirty	90 Max
	Full Load	60 Max
	Daily	45 4 kg
	Fast	20 2 kg
	Delicate	4 kg
	Bedding	4 kg
	Eco Save	Max
	Stain	3 kg
	Machine Clean	No Load
Rinse & Spin	Max	
Spin	Max	
Spin speed (Maximum / Minimum)	800 rpm / 550 rpm	

10. INSTALLATION

10.1 Unpacking

1. Use gloves. Remove the external film. If necessary, use a cutter.

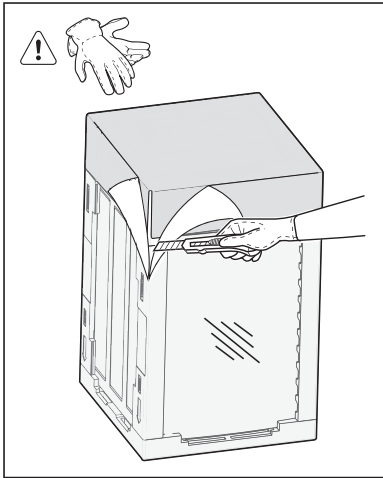

2. Remove the plastic bag which covers the machine. Remove the polystyrene piece.

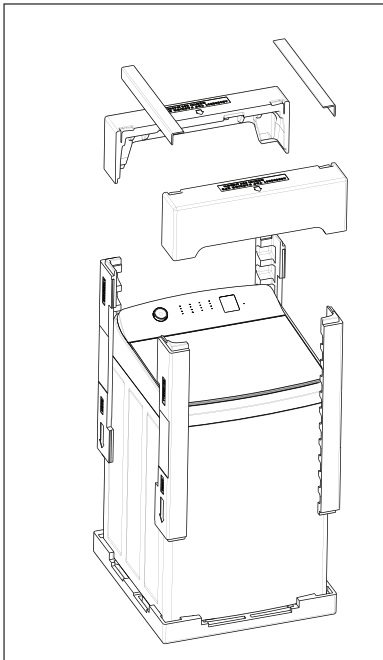

3. Put one of the polystyrene packaging elements on the floor behind the appliance. Carefully put down the appliance with the rear side on it. Make sure not to damage the hoses.

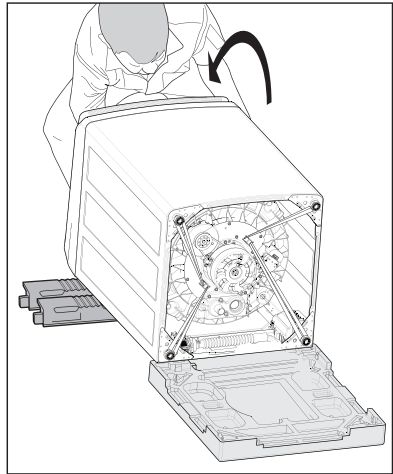

Caution: Pay attention to the machine lid, may hit your body.



4. Cut and remove straps as shown.

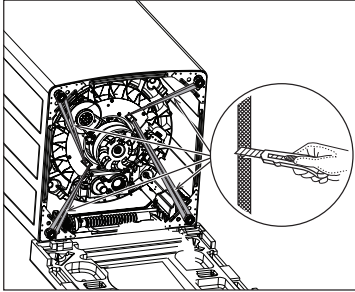

5. Remove the polystyrene base.

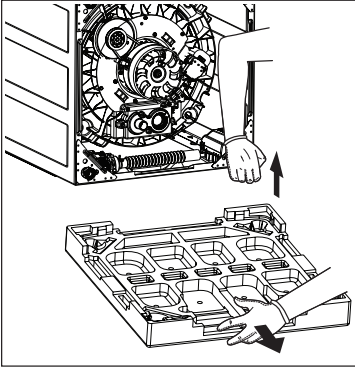

6. Open the lid. Remove the polystyrene piece from the top panel and all the items from the washing tub.

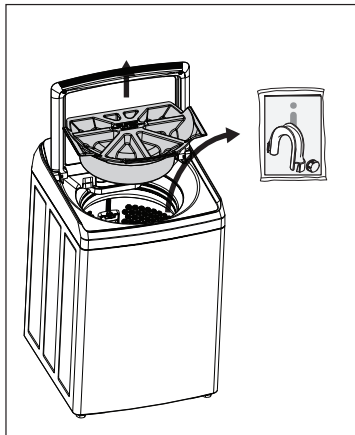

10.2 Positioning

It is important that your washing machine stands firm and level on the floor to ensure correct operation.

Use a spirit level on the front and side panels of the washing machine to check the levels. The spirit level should be used close to the corners of the washing machine for accuracy. By hand, or using a spanner if necessary, adjust the back legs first then the front.

Adjust the four legs up or down as required. You machine may have adjustable legs with a stepped base. If so, please use either a 38 mm or 25 mm spanner or adjust them by hand.

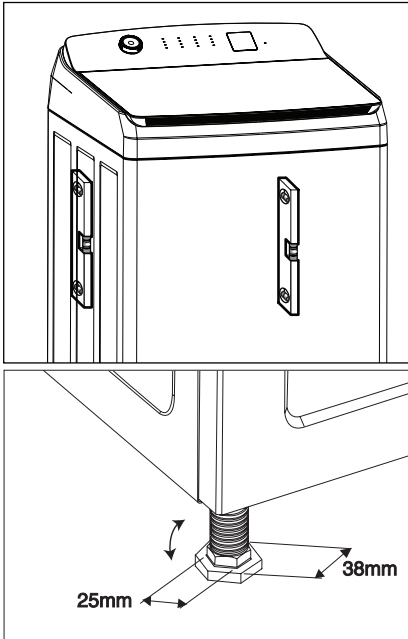

If you do not have spirit level, as a guide use the edge of a door frame, cupboard or bench to check that the washing machine is level.

Never place cardboard, wood or similar materials under the machine to compensate for any unevenness in the floor.

Install the machine on a flat hard floor. Make sure that air circulation around the machine is not impeded by carpets, rugs etc. Check that the machine does not touch the wall or cupboard units.

When the washing machine is levelled, try to rock it from corner to corner. If it does rock, adjust the legs again until it is levelled and does not rock.

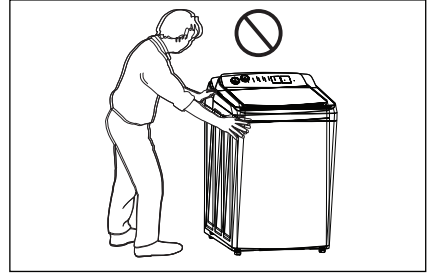

10.3 Water Inlet

Connect the water inlet hose to a tap with 3/4" BSP thread.

When installing this washing machine, use the hoses supplied. **DO NOT USE OLD HOSES.** The inlet hoses have the sealing washer fitted.

Connect the inlet hose to the water tab. Make sure the connections are tight.

Turn the taps on and check that there are no leaks from the connections.

Turn off the water taps and move the washing machine into its final position. Make sure that the inlet and drain hoses do not kink.

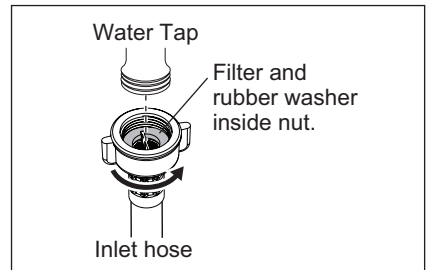

If you only have a cold water tap, you must remove the inlet hose with the RED ends from the washing machine and fit a blank cap with a sealing washer to the HOT water inlet valve, otherwise water will leak out of the valve.

NOTE: With cold water tap only, you must only select cold water temperatures.

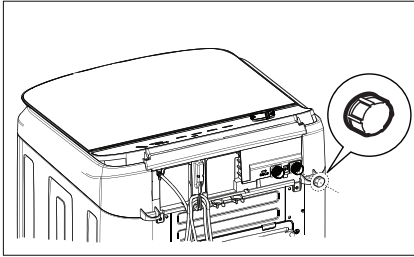

A blank cap is available in the manual bag.

10.4 Water Drainage

1. Fitting hose former.

Obtain hose former from inside the washbowl and fit it to the drain hose.

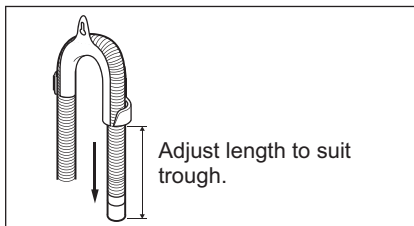
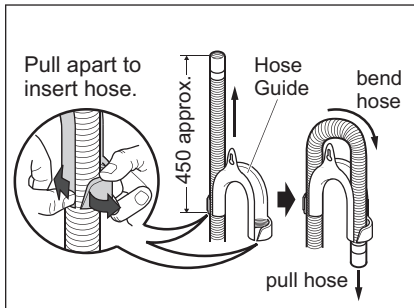

2. Positioning of drain hose.

Adjust the free length of hose to suit your installation.

i It is important that the top of the drain hose is above the joint between the washing machine cabinet and the top panel (see picture).

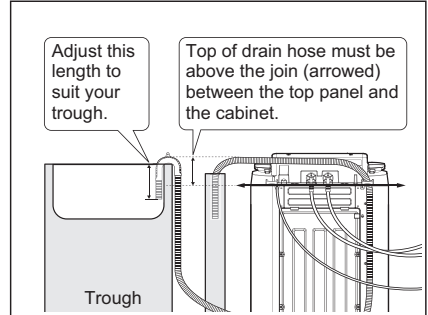

i Please refer to the installation instruction sheet, for more information.

10.5 Electrical Connection

This machine is designed to operate on a 220 - 240 V, single-phase, 50 Hz supply.

“An incorrect power supply may void your warranty.”

Check that your domestic electrical installation can take the maximum load required (2.0 kW), also taking into account any other appliances in use.



CAUTION!

Connect the machine to an earthed socket outlet.



The manufacturer declines any responsibility for damage or injury through failure to comply with the above safety precaution.



Should the appliance power supply cable need to be replaced, this shall be carried out by our Service Centre.

When the appliance is installed, the power supply cable must be easily accessible.

11. ENVIRONMENT CONCERNS

11.1 Packaging Materials



The materials marked with the symbol  are recyclable.

>PE<=polyethylene

>PS<=polystyrene

>PP<=polypropylene

This means that they can be recycled by disposing them properly in appropriate collection containers.

11.2 Old Machine

Use authorized disposal sites for your old appliance. Help to keep your country tidy!

The symbol  on the product or on its packaging indicates that this product may not be treated as household waste.

Instead it shall be handed over to the applicable collection point for the recycling of electrical and electronic equipment. By ensuring this product is disposed of correctly, you will help prevent potential negative consequences for the environment and human health, which could otherwise be caused by inappropriate waste handling of this product.

For more detailed information about recycling of this product, please contact your local city office, your household waste disposal service or the shop where you purchased the product.

11.3 Ecological Hints

To save water, energy and to help protect the environment, we recommend that you follow these tips:

- Normally soiled laundry may be washed without pre washing in order to save detergent, water and time (the environment is protected too!).
- The machine works more economically if it is fully loaded.
- With adequate pre-treatment, stains and limited soiling can be removed; the laundry can then be washed at a lower temperature.
- Measure out detergent according to the water hardness, the degree of soiling and the quantity of laundry being washed.

NOTE

NOTE



Product Date of Purchase

Model Serial Number

Purchaser's Name

Full Postal Address

.....

Retailer (Shop)

Address

Please keep this book and your Proof of Date of Purchase to show the technician if you need service during the warranty period.

Electrolux Warranty

FOR SALES IN AUSTRALIA AND NEW ZEALAND

APPLIANCE: WESTINGHOUSE WASHING MACHINES & WASHER/DRYERS

This document sets out the terms and conditions of the product warranties for Westinghouse Appliances. It is an important document. Please keep it with your proof of purchase documents in a safe place for future reference should there be a manufacturing defect in your Appliance. This warranty is in addition to other rights you may have under the Australian Consumer Law.

1. In this warranty:

- (a) 'ACL' or 'Australian Consumer Law' means Schedule 2 to the Competition and Consumer Act 2010;
- (b) 'Appliance' means any Electrolux product purchased by you and accompanied by this document;
- (c) 'ASC' means Electrolux's authorised serviced centres;
- (d) 'Westinghouse' is the brand controlled by Electrolux Home Products Pty Ltd of 163 O'Riordan Street, Mascot NSW 2020, ABN 51 004 762 341 in respect of Appliances purchased in Australia and Electrolux (NZ) Limited (collectively "Electrolux") of 3-5 Niall Burgess Road, Mount Wellington, in respect of Appliances purchased in New Zealand;
- (e) 'Warranty Period' means the period specified in clause 3 of this warranty;
- (f) 'you' means the purchaser of the Appliance not having purchased the Appliance for re-sale, and 'your' has a corresponding meaning.

2. Application: This warranty only applies to new Appliances, purchased and used in Australia or New Zealand and is in addition to (and does not exclude, restrict, or modify in any way) other rights and remedies under a law to which the Appliances or services relate, including any non-excludable statutory guarantees in Australia and New Zealand.

3. Warranty Period: Subject to these terms and conditions, this warranty continues for in Australia for a period of 24 months and in New Zealand for a period of 24 months following the date of original purchase of the Appliance.

- Inverter motor – Further 8 years

4. Repair or replace warranty: During the Warranty Period, Electrolux or its ASC will, at no extra charge if your Appliance is readily accessible for service, without special equipment and subject to these terms and conditions, repair or replace any parts which it considers to be defective. Electrolux may, in its absolute discretion, choose whether the remedy offered for a valid warranty claim is repair or replacement. Electrolux or its ASC may use refurbished parts to repair your Appliance. You agree that any replaced Appliances or parts become the property of Electrolux.

5. Travel and transportation costs: Subject to clause 7, Electrolux will bear the reasonable cost of transportation, travel and delivery of the Appliance to and from Electrolux or its ASC. Travel and transportation will be arranged by Electrolux as part of any valid warranty claim.

6. Proof of purchase is required before you can make a claim under this warranty.

7. Exclusions: You may not make a claim under this warranty unless the defect claimed is due to faulty or defective parts or workmanship. This warranty does not cover:

- (a) light globes, batteries, filters or similar perishable parts;
- (b) parts and Appliances not supplied by Electrolux;
- (c) cosmetic damage which does not affect the operation of the Appliance;

- (d) damage to the Appliance caused by:
 - (i) negligence or accident;
 - (ii) misuse or abuse, including failure to properly maintain or service;
 - (iii) improper, negligent or faulty servicing or repair works done by anyone other than an Electrolux authorised repairer or ASC;
 - (iv) normal wear and tear;
 - (v) power surges, electrical storm damage or incorrect power supply;
 - (vi) incomplete or improper installation;
 - (vii) incorrect, improper or inappropriate operation;
 - (viii) insect or vermin infestation;
 - (ix) failure to comply with any additional instructions supplied with the Appliance;

In addition, Electrolux is not liable under this warranty if:

- (a) the Appliance has been, or Electrolux reasonably believes that the Appliance has been, used for purposes other than those for which the Appliance was intended, including where the Appliance has been used for any non-domestic purpose;
- (b) the Appliance is modified without authority from Electrolux in writing;
- (c) the Appliance's serial number or warranty seal has been removed or defaced.

8. How to claim under this warranty: To enquire about claiming under this warranty, please follow these steps:

- (a) carefully check the operating instructions, user manual and the terms of this warranty;
- (b) have the model and serial number of the Appliance available;
- (c) have the proof of purchase (e.g. an invoice) available;
- (d) telephone the numbers shown below.

9. Australia: For Appliances and services provided by Electrolux in Australia: Electrolux goods come with guarantees that cannot be excluded under the Australian Consumer Law. You are entitled to a replacement or refund for a major failure and for compensation for any other reasonably foreseeable loss or damage. You are also entitled to have the Appliance repaired or replaced if the Appliance fails to be of acceptable quality and the failure does not amount to a major failure. 'Acceptable quality' and 'major failure' have the same meaning as referred to in the ACL.

10. New Zealand: For Appliances and services provided by Electrolux in New Zealand, the Appliances come with a guarantee by Electrolux pursuant to the provisions of the Consumer Guarantees Act, the Sale of Goods Act and the Fair Trading Act. Where the Appliance was purchased in New Zealand for commercial purposes the Consumer Guarantee Act does not apply.

11. Confidentiality: You accept that if you make a warranty claim, Electrolux and its agents including ASC may exchange information in relation to you to enable Electrolux to meet its obligations under this warranty.

Important Notice

Before calling for service, please ensure that the steps listed in clause 8 above have been followed.

AUSTRALIA	FOR SERVICE or to find the address of your nearest authorised service centre in Australia PLEASE CALL 13 13 49 For the cost of a local call	FOR SPARE PARTS or to find the address of your nearest spare parts centre in Australia PLEASE CALL 13 13 50 For the cost of a local call
NEW ZEALAND	FOR SERVICE or to find the address of your nearest authorised service centre in New Zealand PLEASE CALL 0800 10 66 10	FOR SPARE PARTS or to find the address of your nearest spare parts centre in New Zealand PLEASE CALL 0800 10 66 20



www.westinghouse.com.au
www.westinghouse.co.nz



G0038509-001-A12246437