

MICROWAVE OVEN

WMB4425SC,WMB4425DSC

CONGRATULATIONS

Dear customer,
Congratulations on the purchase of your new microwave.
Before you use the microwave, we recommend that you read through the whole user manual which provides the description of the microwave and its functions.
To avoid the risks that are always present when you use an electrical appliance, it is important that the microwave is installed correctly and that you read the safety instructions carefully to avoid misuse and hazards.
We recommend that you keep this instruction booklet for future reference and pass it on to any future owners.
After unpacking the appliance, please check it is not damaged. If in doubt, do not use the appliance but contact your local Customer Care Centre.
For contact details, refer to the last page of this user manual.

Conditions of use

This appliance is intended to be used in household and similar applications such as:

- Staff kitchen areas in shops, offices and other working environments
- Farm houses
- By clients in hotels, motels and other residential type environments
- Bed and breakfast type environments

Please ensure you read the instruction manual fully before you call for service, or a full service fee could be applicable.

Record model and serial number here:
Model number:.....
Serial number:.....
PNC:.....

IMPORTANT INFORMATION THAT MAY IMPACT YOUR MANUFACTURER'S WARRANTY
Adherence to the directions for use in this manual is extremely important for health and safety. Failure to strictly adhere to the requirements in this manual may result in personal injury, property damage and affect your ability to make a claim under the Westinghouse manufacturer's warranty provided with your product. Products must be used, installed and operated in accordance with this manual. You may not be able to claim on the Westinghouse manufacturer's warranty in the event that your product fault is due to failure to adhere to this manual.

CONTENTS

General warnings.....3
 Important safety instructions..... 4
 Product description5
 Control panel.....5
 Before using your appliance for the first time..... 6
 Daily use7
 Automatic programmes.....10
 Using the accessories 12
 Additional functions 12
 Helpful hints and tips 13
 Care and cleaning 13
 Troubleshooting.....14
 Installation 15
 Electrical Installation 17
 Warranty.....18

Please read the user manual carefully and store in a handy place for later reference.

The symbols you will see in this booklet have these meanings:

 **WARNING**
This symbol indicates information concerning your personal safety.

 **CAUTION**
This symbol indicates information on how to avoid damaging the appliance.

 **IMPORTANT**
This symbol indicates tips and information about use of the appliance.

 **ENVIRONMENT**
This symbol indicates tips and information about economical and ecological use of the appliance.

GENERAL WARNINGS

Please read the user manual carefully and store in a handy place for later reference. Pass the user manual on to possible new owners of the appliance.

Read the following carefully to avoid damage or injury.

NOTE: You must read these warnings carefully before installing or using the appliance. If you need assistance, contact your Customer Care Department. The manufacturer will not accept liability, should these instructions or any other safety instructions incorporated in this book be ignored.

Children and vulnerable people safety.



WARNING

Risk of suffocation, injury or permanent disability.

- This appliance is not intended for use by persons (including children) with reduced physical, sensory or mental capabilities, or lack of experience and knowledge, unless they have been given supervision or instruction concerning use of the appliance by a person responsible for their safety.
- Children should be supervised to ensure that they do not play with the appliance.
- Keep all packaging away from children.
- Keep children and pets away from the appliance when it operates or when it cools down. Accessible parts are hot.
- If the appliance has a child safety device, we recommend that you activate it.
- Cleaning and user maintenance shall not be made by children without supervision.
- Keep the appliance and its cord out of reach of children less than 8 years.



CAUTION

It is important to use your appliance safely. Check these safety points before using your appliance.

General safety

- Internally the appliance becomes hot when in operation. Do not touch the heating elements that are in the appliance. Always use oven gloves to remove or put in accessories or ovenware.
- Do not use a steam cleaner to clean the appliance.
- Before maintenance isolate the power supply.
- Warning: Ensure that the appliance is switched off before replacing the lamp to avoid electric shock.
- If the door or door seals are damaged, the appliance must not be operated until it has been repaired by a competent person.
- The appliance is not intended to be operated by means of an external timer or separate remote-control system..
- Only a competent person can carry out any service or repair operation that involves the removal of a cover which gives protection against exposure to microwave energy.

- Do not heat liquids and other foods in sealed containers. They are liable to explode.
- Only use utensils that are suitable for use in microwave ovens.
- Metallic containers for food and beverage are not allowed during microwave cooking.
- When heating food in plastic or paper containers, keep an eye on the appliance due to the possibility of ignition.
- The appliance is intended for heating food and beverages. Drying of food or clothing and heating of warming pads, slippers, sponges, damp cloth and similar may lead to risk of injury, ignition or fire.
- If smoke is emitted, switch off or unplug the appliance and keep the door closed in order to stifle any flames.
- Microwave heating of beverages can result in delayed eruptive boiling. Care must be taken when handling the container.
- The contents of feeding bottles and baby food jars should be stirred or shaken and the temperature checked before consumption, in order to avoid burns.
- Eggs in their shell and whole hard-boiled eggs should not be heated in the appliance since they may explode, even after microwave heating has ended.
- The appliance should be cleaned regularly and any food deposits removed.
- Failure to maintain the appliance in a clean condition could lead to deterioration of the surface that could adversely affect the life of the appliance and possibly result in a hazardous situation.
- WARNING: Accessible parts may become hot during use. Young children should be kept away.
- Pay attention to the minimum dimensions of the cabinet (if applicable). Refer to the installation chapter.
- This appliance must not be installed behind a decorative door in order to avoid over heating.
- Do not use harsh abrasive cleaners or sharp metal scrapers to clean the glass door since they can scratch the surface, which may result in shattering of the glass.
- If the supply cord is damaged, it must be replaced by the manufacturer, an authorised Service or similarly qualified persons in order to avoid a hazard.
- CAUTION: In order to avoid a hazard due to inadvertent resetting of the thermal cutout, this appliance must not be supplied through an external switching device, such as a timer, or connected to a circuit that is regularly switched on and off by the utility.

SAFETY INSTRUCTIONS

Installation



WARNING

Only a qualified person must install this appliance.

- Remove all the packaging.
- Do not install or use a damaged appliance.
- Obey the installation instructions supplied with the appliance.
- Always be careful when you move the appliance because it is heavy. Always wear safety gloves.
- Keep the minimum distance from the other appliances and units.
- Make sure that the appliance is installed below and adjacent safe structures.

Electrical connection



WARNING

Risk of fire and electrical shock.

- All electrical connections should be made by a qualified electrician.
- The appliance must be earthed.
- Make sure that the electrical information on the rating plate agrees with the power supply. If not, contact an electrician.
- This appliance is supplied with a mains cable suitable for hard wire connection by a suitably qualified electrician.
- Means for disconnection from the mains power supply with at least 3mm contact separation on all poles must be incorporated in the fixed wiring in accordance with the wiring rules.
- Make sure not to cause damage to the mains cable. Contact the Service Centre or an electrician to change a damaged mains cable.

Use



WARNING

Risk of injury, burns or electric shock or explosion.

- Use this appliance in a household environment.
- Do not change the specification of this appliance.
- Make sure that the ventilation openings are not blocked.
- Do not let the appliance stay unattended during operation.
- Do not apply pressure on the open door.
- Do not use the appliance as a work surface and do not use the cavity for storage purposes.

Care and cleaning



WARNING

Risk of injury, fire or damage to the appliance.

- Before maintenance, deactivate the appliance by switching off the power isolation switch.
- Regularly clean the appliance to prevent the deterioration of the surface material.
- Do not allow food spills or cleaner residue to accumulate on door sealing surfaces.
- Remaining fat or food in the appliance can cause smoke/fire, particularly on the grill element.
- Clean the appliance with a moist soft cloth. Only use neutral detergents. Do not use abrasive products, abrasive cleaning pads, solvents or metal objects.
- If you use an oven spray, obey the safety instructions on the packaging.

Disposal



WARNING

Risk of injury or suffocation through misuse of packaging and/or discarded product.

- Disconnect the appliance from the mains supply.
- Cut off the mains cable and discard it.

PRODUCT DESCRIPTION

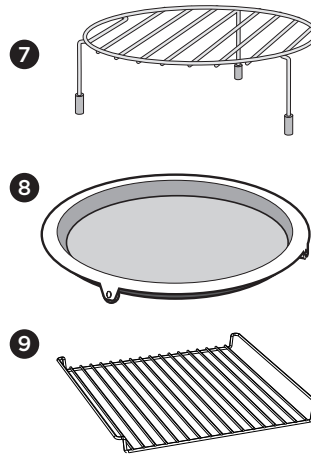
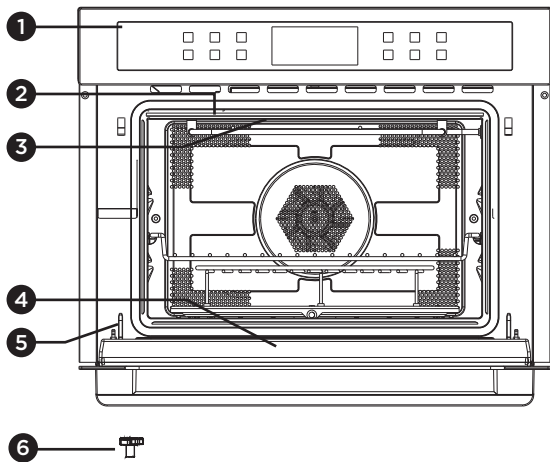

- 1 Control panel
- 2 Grill element
- 3 Light
- 4 Door glass
- 5 Hinge
- 6 Turntable shaft
- 7 Grill Rack
- 8 Grill Pan
- 9 Grill Shelf

Control panel

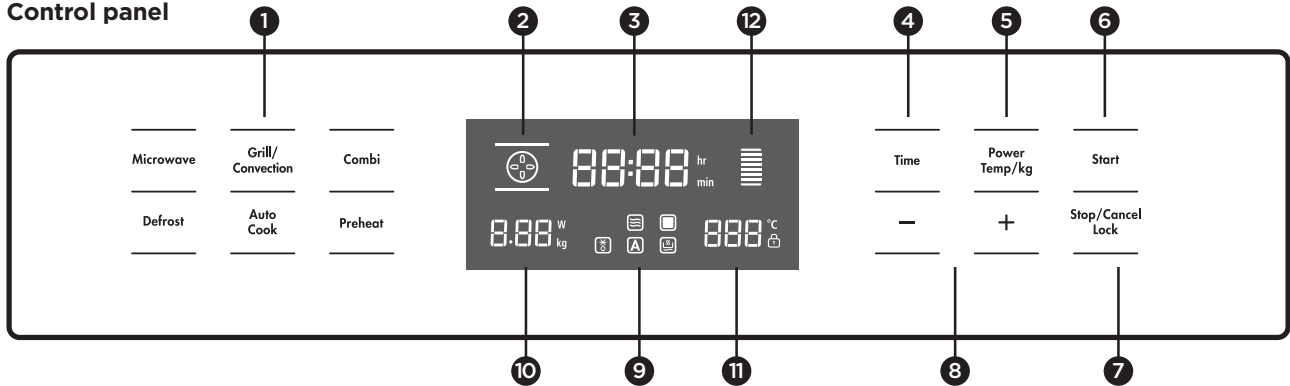

| SYMBOL | FUNCTION | DESCRIPTION |
|------------------------------|-----------------------------------|---|
| 1 | Function pads | To set various cooking functions |
| 2 | Function display | Displays cooking function active |
| 3 | Time display | Displays cooking time or clock function |
| 4 Time | Time | To set clock or cooking time |
| 5 Power Temp/kg | Function pad | To adjust power/ temperature or weight |
| 6 Start | Start | To start or resume a cooking cycle |
| 7 Stop/Cancel Lock | Stop/Cancel/Lock | To stop or reset a cooking function and activate child lock |
| 8 - + | Setting pads | To adjust settings |
| 9 | Function display | Shows defrost function active |
| | Function display | Shows microwave function is active |
| | Function display | Shows a heating function is active |
| | Function display | Shows auto function active |
| | Function display | Shows preheat function active |
| 10 | Weight OR microwave power display | Weight OR microwave power display |
| 11 | Set temperature display | |
| 12 | Heat up display | |

BEFORE FIRST USE



WARNING

Refer to the safety chapters.

Initial cleaning and heating

Removing the microwave oven all of the protection foil on the front. For more information see the chapter "CARE AND CLEANING".

Before the first use of the appliance,

- Before any functions can be activated the clock needs to be set. Refer clock setting instructions below.
- Before heating wipe the microwave oven interior with a damp cloth to remove any residual packing material.
- Touch **Grill/Convection** to choose the convection function. Default temperature is 180°C. Press **Power Temp/kg** so that temperature flashes, then use + to increase the temperature.
- Raise the temperature to 230°C (maximum temperature). This can be achieved by using beside proximity keys or the numeric keypad.
- Touch **Start** symbol next to the sensor keys. Heat the empty oven for at least an hour.

When you do this, make sure that the room is well ventilated. Close the door to any other rooms to avoid odor spreading through the house.

- Let the appliance cool down to room temperature. Use a solution of neutral detergent mixed with hot water to clean inside the microwave oven, then wipe dry with a clean soft cloth. Keep the door open until the inside of the oven is completely dry.

Clock Setting

When the microwave oven is turned on, "00:00" will blink, buzzer will ring once.

1. Press **-** or **+** to set the right time (between 00:00 and 23:59.)
2. After you have set the right time, press **Time**. The clock has been set.

Changing the time

1. If you want to change the time, you have to press and hold the **Time** button for 3 seconds. The actual time disappears and then the time will blink in the display. Press **-** or **+** to set the new time and press the **Time** button to confirm the setting.
2. When you set the clock, press **-** or **+** when adjusting 10MIN, short press time (each time you adjust 1MIN).

DAILY USE



WARNING

Refer to the safety chapters.



CAUTION

Do not let the appliance operate when there is nothing inside.

General information about using the appliance

General:

- After you deactivate the appliance, let the food stand for some minutes.
- Remove the aluminium foil packaging, metal containers, etc before you prepare the food.

Cooling fan:

When the appliance operates, the cooling fan activates automatically to keep the surfaces of the appliance cool. If you deactivate the appliance, the cooling fan can continue to operate until the appliance cools down.

Resuming cooking after opening door:

The “start” button must be pressed to continue cooking if the oven door has been opened during cooking process.

Cooking:

- If possible, cook food covered with material suitable for use in the microwave. Only cook food without a cover if you want to keep it crusty.
- Do not overcook the dishes by setting the power and time too high. The food can dry out, burn or catch fire in some places.
- Do not use the appliance to cook eggs or snails in their shells, because they can explode. With fried eggs, pierce the yolks first.
- Prick food with “skin” or “peel”, such as potatoes, tomatoes, sausages, with a fork several times before cooking so that the food does not explode.
- For chilled or frozen food, set a longer cooking time.
- Dishes which contain sauce must be stirred from time to time.
- Vegetables that have a firm structure, such as carrots, peas or cauliflower, must be cooked in water.
- Turn larger pieces after half of the cooking time.
- If possible, cut vegetables into similar sized pieces.
- Use flat, wide dishes.
- Do not use cookware made of porcelain, ceramic or earthenware with small holes, e.g. on handles or unglazed bottoms. Moisture going into the holes can cause the cookware to crack when it is heated.
- The cooking tray must be used for heating food or liquids. It is necessary for the operation of the microwave.

Defrosting meat, poultry, fish:

- Put the frozen, unwrapped food on a small upturned plate with a container below it so that the defrosting liquid collects in the container.
- Turn the food after half of the defrosting time. If possible, divide and then remove the pieces that started to defrost.

Defrosting butter, portions of gâteau, soft cheeses:

- Do not fully defrost the food in the appliance, but let it defrost at room temperature. This gives a more even result. Fully remove all metal or aluminium packaging before defrosting.

Defrosting fruit, vegetables:

- Do not fully defrost fruit and vegetables, which are to be further prepared while raw, in the appliance. Let them defrost at room temperature.
- You can use a higher microwave power to cook fruit and vegetables without defrosting them first.

Ready meals:

- You can prepare ready meals in the appliance only if their packaging is suitable for microwave use.
- You must follow the manufacturer's instructions printed on the packaging (e.g. remove the metal cover and pierce the plastic film).

DAILY USE (CONTINUED)

Suitable cookware and materials

| COOKWARE / MATERIAL | MICROWAVE | | | GRILLING/ CONVECTION |
|---|------------|---------|---------|-------------------------|
| | DEFROSTING | HEATING | COOKING | |
| Ovenproof glass and porcelain (with no metal components, e.g. Pyrex, heat-proof glass) | ✓ | ✓ | ✓ | ✓ |
| Non-ovenproof glass and porcelain ¹ | ✓ | -- | -- | -- |
| Glass and glass ceramic made of ovenproof / frost-proof material (e.g. Arcoflam), grill shelf | ✓ | ✓ | ✓ | ✓ |
| Ceramic ² , earthenware ² | ✓ | ✓ | ✓ | -- |
| Heat-resistant plastic up to 200°C ³ | ✓ | ✓ | ✓ | -- |
| Cardboard, paper | ✓ | -- | -- | -- |
| Clingfilm | ✓ | -- | -- | -- |
| Roasting film with microwave safe closure ³ | ✓ | ✓ | ✓ | -- |
| Roasting dishes made of metal, e.g. enamel, cast iron | -- | -- | -- | ✓ |
| Baking tins, black lacquer or silicon coated ³ | -- | -- | -- | ✓ |
| Baking tray | -- | -- | -- | ✓ |
| Browning cookware, e.g. Crisp pan or Crunch plate | -- | ✓ | ✓ | -- |
| Ready meals in packaging ³ | ✓ | ✓ | ✓ | ✓ |

1. With no silver, gold, platinum or metal plating / decorations.

2. Without quartz or metal components, or glazes which contain metals.









3. You must follow the manufacturer's instructions about the maximum temperatures.

DAILY USE (CONTINUED)

Cooking guide

| FOOD | COOKING FUNCTION | TEMP (°C) | MICROWAVE POWER (W) | TIME (MIN) |
|------------------|------------------------------|-----------|---------------------|--|
| Scones | Fan Bake | 210 | N/A | 10 |
| Cup Cakes | Fan Bake | 180 | N/A | 17 |
| Sponge cake | Fan Bake | 170 | N/A | 30 |
| Soup | Microwave | N/A | N/A | 5 min on 450W then 5 min on 900W |
| Rice | Microwave | N/A | N/A | 5 min on 900W, stir then 5 min on 900W |
| Pasta | Microwave | N/A | N/A | 5 min on 900W, stir then 5 min on 900W |
| Pizza | Fan Bake | 210 | N/A | 18 |
| Potato Bake | Combi, microwave + Fan Grill | 180 | 700 | 15 |
| Stuffed zucchini | Microwave + fan grill | 180 | N/A | 10 |
| Chicken wings | Combi, microwave + Fan Grill | 180 | 30 | 30 (turned every 10) |
| Roast chicken | Combi, microwave + Fan bake | 180 | 700 | 20 |
| Roast potato | P03 | P03 | N/A | P03 |
| Sausages | P04 | P04 | N/A | P04 |

Power setting table

| FUNCTION | MODE | | | |
|---|---|------------------------------------|--|--|
| Microwave Microwave |  | Microwave | Use the microwave function to cook and reheat vegetables, potatoes, rice, fish and meat. | |
| Grill/Convection Heating |  | Hot Air | With hot air you can prepare meals in the same way as you do with a conventional oven. The microwave is not activated. You are advised to preheat the oven before putting the meal in the oven. | |
| |  | Grill with fan | Use this function to roast meals evenly and at the same time give the meal a brown crust. | |
| |  | Top Grill | The grill is ideal to prepare thin pieces of meat and fish. | |
| |  | Bottom Grill + Hot Air | Bottom grill with fan. | |
| Microwave + Grill/Convection Combination |  | Microwave + Hot Air | Use this function to roast meals quickly. | |
| |  | Microwave + Grill with fan | Microwave and grill with fan. | |
| |  | Microwave + Top Grill | Use this function to cook meals quickly and at the same time give the meal a brown crust (also au gratin). The microwave and the grill are activated at the same time. The microwave is cooking and the grill is roasting. | |
| |  | Microwave + Bottom Grill + Hot Air | Microwave and grill with fan. | |
| Auto Cook Auto-programs | | P01 - P13 | Automatic cooking programs | |
| Defrost Defrost | | d01 + d02 | Defrost | |

AUTOMATIC FUNCTIONS

Microwave Cooking

1. Press the **Microwave** button to activate the microwave function. "01:00" blinks in the display and "min" icon appears.
2. use the **-** or **+** buttons to adjust the cooking time. The max. cooking time depends on the power. The power is 900W, the MAX. time is 30 minutes and other powers are 90 minutes.
3. Press **Power Temp/kg** to set the microwave power. To adjust the microwave power (between 100W and 900W) use **-** or **+** buttons. If no operation in 10 seconds, the current power will be confirmed automatically.
4. Press **Start** button to start cooking.



WARNING

Internally the appliance becomes hot when in use. Take care not to touch the grill element when putting in and removing food.

Traditional Cooking functions (without microwave)

1. Press **Grill/Convection**
2. Press **Grill/Convection** or **-** or **+** to select the desired cooking mode.
3. Adjust power/temperature setting as required
 - Grilling: default grill power is 3. Press **Power Temp/kg** then **-** or **+** to adjust from 3 (Max) to 1 (Min) power.
 - Convection: default temperature is 180°C. Press **Power Temp/kg** then **-** or **+** to adjust from 70 to 230°C.

NOTE: setting a function below 70°C should be used for plate warming only, not cooking food.



 - Grill with fan: default temperature is 180°C Press **Power Temp/kg** then **-** or **+** to adjust from 100 to 230°C.
4. Press **Time** then **-** or **+** to adjust the time (default is 10 min for grilling and convection).
Max time Grilling is 90 minutes.
Max time Convection is 5 hours.
Max time Grill with Fan is 5 hours.
Max time Bottom Grill + Convection is 5 hours.
5. Press **Start** to start cooking.



WARNING

Internally the appliance becomes hot when in use. Take care not to touch the grill element when putting in and removing food.

Microwave + Grill Cooking

1. Press **Combi** button to activate the microwave function.
2. Press **Combi (Microwave** and  icon will light). Press **Combi** until the  indicator for grill function is on the display.
3. Press **Power Temp/kg** to enter to the grill power level selection.
4. Press **-** or **+** to select the power.

5. To adjust the microwave power press **Power Temp/kg** again until the default microwave power of 300W flashes.
6. Press **-** or **+** to select 700W, 450W, 300W and 100W.
7. Press **Time** to select the time setting mode. The default time is 10 minutes.
8. Press **-** or **+** to select the cooking time. The max. time is 90 minutes.
9. Press **Start** button to start cooking.

Microwave + Convection Cooking



1. Press **Combi** to select combination modes. Convection mode is default. The default temperature is 180°C,
2. Press **Power Temp/kg** to enter to the temperature selection.
3. Press **-** or **+** to select the temperature between 70 to 230°C.
4. To adjust the microwave power press **Power Temp/kg** again until the default microwave power of 300W flashes.
5. Press **-** or **+** to select 700W, 450W, 300W and 100W.
6. Press **Time** to select the time setting mode. The default time is 10 minutes.
7. Press **-** or **+** to select the cooking time of grill. The max. time is 90 minutes.
8. Press **Start** button to start cooking.

Microwave + Grill Fan Cooking



WARNING

Internally the appliance becomes hot when in use. Take care not to touch the grill element when putting in and removing food.

1. Press **Combi** button to activate the microwave function.
2. Press **Combi** or **-** or **+** to select the combination mode.  and  will light.
3. Press **Combi** or **-** or **+** to select grill with fan mode. The default temperature is 180°C.  lights.
4. Press **Power Temp/kg** to enter to the temperature selection.
5. Press **-** or **+** to select the temperature between 100 to 230°C.
6. Press **Power Temp/kg** to select the power. The default power is 300W.
7. Press **-** or **+** to select 700W, 450W, 300W and 100W.
8. Press **Time** to select the time setting mode. The default time is 10 minutes.
9. Press **-** or **+** to select the cooking time of grill. The max. time is 90 minutes.
10. Press **Start** button to start cooking.

AUTOMATIC FUNCTIONS (CONTINUED)

Microwave + Bottom Grill + Convection Cooking



WARNING

Internally the appliance becomes hot when in use. Take care not to touch the grill element when putting in and removing food.

1. Press **Combi** button to select combination modes.
2. Press **Combi** or **—** or **+** to select Microwave+Bottom Grill+Convection mode. The default temperature is 180°C.
3. Press **Power Temp/kg** to enter to the temperature selection.
4. Press **—** or **+** to select the temperature between 100 to 230°C.
5. Press **Power Temp/kg** to select the power. The default power is 300W.
6. Press **—** or **+** to select 700W, 450W, 300W and 100W.
7. Press **Time** to select the time setting mode. The default time is 10 minutes.
8. Press **—** or **+** to select the cooking time of grill. The max. time is 90 minutes.
9. Press **Start** button to start cooking.

Auto Cook

There are 13 automatic cooking programs. You only have to choose the program and set the weight. The power, the time and the temperature are already set.

1. Press **Defrost** or **Auto Cook** button to activate the desired microwave program.
2. Press **—** or **+** to select the desired program (“d01” or “d02” from defrost, “P01”- “P13” from Auto Cook)
4. Press **Power Temp/kg** button.
5. Press **—** or **+** to select weight of the menu.
6. Press **Start** button to start cooking.

| PROGRAM | CATEGORY | ITEM |
|-----------------|------------------------|--|
| d01 (defrost)** | Meat, poultry and fish | If you hear a beep, the combi microwave oven stops. Turn the food and press the start/pause button to continue the defrosting program. |
| d02 (defrost)** | Bread, cake and fruit | |
| P01** | Vegetables | Fresh vegetables |
| P02** | Side dishes | Potatoes - peeled/cooked |
| P03* | Side dishes | Potatoes - roasted If you hear a beep, turn the food. The combi microwave oven starts the next phase automatically. |
| P04 | Poultry/Fish | Chicken pieces/ Fish pieces If you hear a beep, turn the food. The combi microwave oven starts the next phase automatically. |
| P05* | Baking | Cake |
| P06* | Baking | Apple pie |
| P07* | Baking | Quiche |
| P08** | Reheat | Drink/soup |
| P09** | Reheat | Plated meal |
| P10** | Reheat | Sauce/stew/dish |
| P11* | Frozen | Pizza |
| P12* | Frozen | Oven chips |
| P13* | Frozen | Lasagne |

- The programmes with a * are preheated. During preheating, the cooking time pauses and the preheating symbol is on. After preheating, you will hear an alarm and the preheating symbol will blink. The oven is now ready. After putting what you want to cook in the oven press **Start** to activate the timer.
- The programmes with ** only use the microwave function.

Preheating Function

The preheating function can be activated after you have chosen the functions: Convection, Grill fan, MW-convection, MW-Grill fan.

1. Press **Preheat** button. The preheat icon appears in the display.
2. Press **Start** button to start preheating. Horizontal bars on the right hand side of the time display indicate that the function is operating. If the door is opened the preheating functions stops and the horizontal bars turn off.

*NOTE: To recommence a preheating cycle after the door is opened the cooking function and preheating will need to be reprogrammed. Pressing **Start** will immediately commence the cooking function selected. You can also stop the preheating by pressing the **Stop/Cancel Lock** button.*

NOTE: The preheating function only works if you have already chosen one of the modes above. During preheating, the microwave function is switched off.

Display Specification

1. After selecting an option it will be confirmed automatically after three seconds.
2. When the oven is in setting or paused state it will revert to off state after 5 min if no operation is selected
3. The oven light will stay on if the door is left open or the oven is paused
4. The **Start** button must be pressed to continue cooking if the oven door is opened during the cooking process

USING THE ACCESSORIES



WARNING

Refer to the safety chapter.



CAUTION

Do not cook food without the turntable set. Only use the turntable set provided with the appliance.



IMPORTANT

Never cook food directly on the cooking tray.

Turntable installation

- Never place the enamel tray upside down. The enamel tray should never be restricted.
- The enamel tray must always be used during cooking.
- All food and containers of food should always be placed on the enamel tray for cooking.
- If the enamel tray cracks or breaks, contact your nearest authorised service centre.

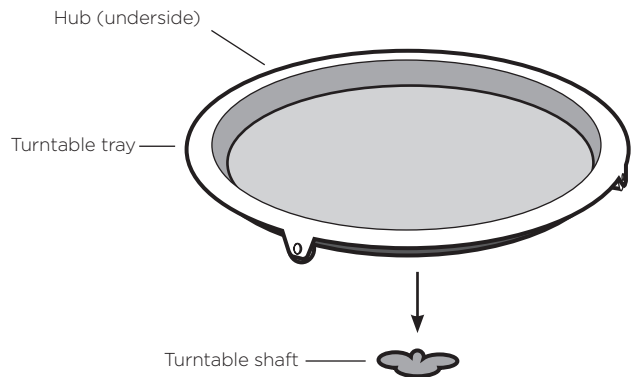

Inserting the grill rack

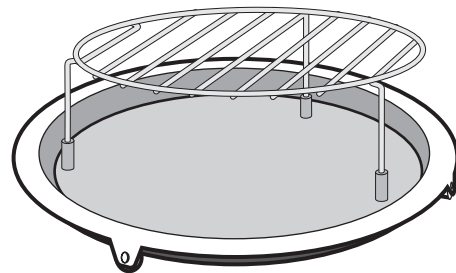

Place the grill rack on the turntable set.

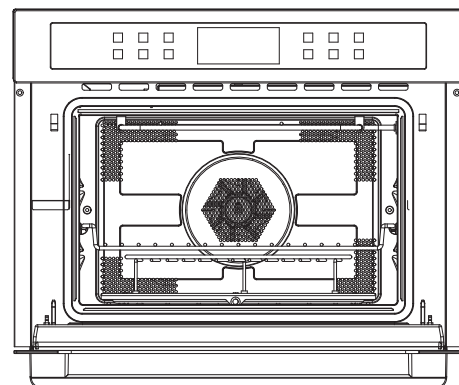

Install the grill shelf on the grill shelf support as pictured above.

Note: The metal grill rack and grill shelf can be used with any cooking mode, including microwave mode.

ADDITIONAL FUNCTIONS

Lock-out Function for Children

Lock:

In waiting state, press **Stop/Cancel Lock** for 3 seconds, there will be a long “beep” denoting entering into the children-lock state and  indicator will light.

Unlock:

In locked state, press **Stop/Cancel Lock** for 3 seconds, there will be a long “beep” denoting that the lock is released, and  indicator will disappear.

HELPFUL HINTS AND TIPS

Power setting table

| PROBLEM | REMEDY |
|--|---|
| You cannot find details for the amount of food prepared. | Look for a similar food. Increase or shorten the length of the cooking times according to the following rule: Double the amount = almost double the time, Half the amount = half the time |
| The food got too dry. | Set shorter cooking time or select lower microwave power. |
| The food is not defrosted, hot or cooked after the time came to an end. | Set longer cooking time or set higher power. Note that large dishes need longer time. |
| After the cooking time comes to an end, the food is overheated at the edge but is still not ready in the middle. | Next time set a lower power and a longer time. Stir liquids halfway through, eg. soup. |

To get better results for rice use a flat, wide dish.

Defrosting

Always defrost roast with the fat side down. Do not defrost covered meat because this may cause cooking instead of defrosting. Always defrost whole poultry breast side down.

Cooking

Always remove chilled meat and poultry from the refrigerator at least 30 minutes before cooking. Let the meat, poultry, fish and vegetables stay covered after cooking.

Brush a little oil or melted butter over the fish. Add 30-45ml of cold water for every 250g of vegetables. Cut the fresh vegetables into even size pieces before cooking. Cook all vegetables with a cover on the container.

Reheating

When you reheat packed ready meals always follow the instructions written on the packaging.

Grilling

Grill flat food items in the middle of the grill rack. Turn the food over halfway through the set time and continue grilling.

Convection Cooking

You can cook food as in a traditional oven. No microwaves are used.

Combi Cooking

Use the Combi Cooking to keep the crispness of certain foods. At the half of the cooking time, turn over the foods then continue. Each mode combines the microwave, grill and convection functions at different time periods and power levels.

CARE AND CLEANING



WARNING

Refer to the safety chapters.

Notes on cleaning:

- To clean the fingerprint-resistant stainless steel front panel, simply wipe with a soft cloth using warm water and a mild detergent. DO NOT use stainless steel cleaners, abrasive cleaners or harsh solvents.
- Clean the appliance interior after each use. You will be able to remove dirt more easily and it will not burn on.
- Clean stubborn dirt with a special cleaner.
- Clean all accessories regularly and let them air dry. Use a soft cloth with warm water and a cleaning agent.
- Boil a glass of water at full microwave power for 2 to 3 minutes to soften and remove dried on remains.
- To remove odours, mix a glass of water with 2 tsp of lemon juice and boil at full microwave power for 5 minutes.

TROUBLESHOOTING



WARNING

Refer to the safety chapters.

| PROBLEM | POSSIBLE CAUSE | REMEDY |
|---|---|--|
| The appliance does not operate. | <ul style="list-style-type: none"> The appliance is deactivated. The appliance is not plugged in. The fuse in the fuse box is blown. The door is not closed properly. | <ul style="list-style-type: none"> Activate the appliance. Plug in the appliance. Check the fuse. If the fuse blows more than one time, contact a qualified electrician. Make sure that nothing blocks the door. |
| The light does not operate. | <ul style="list-style-type: none"> The light is defective. | <ul style="list-style-type: none"> The light bulb has to be replaced. Contact the customer service centre. |
| The display shows. | <ul style="list-style-type: none"> The Child Safety Lock is active. | <ul style="list-style-type: none"> Deactivate the Child Safety Lock. Hold the Cancel button for 3 seconds. |
| There is sparking in the cavity. | <ul style="list-style-type: none"> There are metal dishes or dishes with metal trim inside. | <ul style="list-style-type: none"> Remove the dish from the appliance. |
| | <ul style="list-style-type: none"> There are metal skewers or aluminium foil touching the interior walls. | <ul style="list-style-type: none"> Make sure that the skewers and foil does not touch the interior walls. |
| The turntable set makes scratching or grinding noise or does not rotate smoothly. | <ul style="list-style-type: none"> There is an object or dirt below the cooking tray. | <ul style="list-style-type: none"> Clean the area below the cooking tray including rollers. Check turntable roller assembly and glass are installed correctly. |
| The appliance stops operating without a clear reason. | <ul style="list-style-type: none"> There is a malfunction. | <ul style="list-style-type: none"> Check ventilation of the unit is not obstructed. If this situation repeats with correct installation, call the customer service centre. |
| Microwave runs cooking cycle but food does not heat up. | <ul style="list-style-type: none"> Internal self-resetting thermostat has activated. The microwave is fitted with a thermostat to protect internal components from overheating. | <ul style="list-style-type: none"> Once the thermostat's temperature has reduced the unit should function normally. Wait 5 minutes then try the appliance again. |
| Steam accumulating on microwave oven door or leaking from vents. | <ul style="list-style-type: none"> Cooking foods with a high moisture content will always produce steam. | <ul style="list-style-type: none"> This is a normal part of the cooking process. |
| Smoke during cooking process. | <ul style="list-style-type: none"> Fat accumulated on cavity grill element. | <ul style="list-style-type: none"> Ensure inside of unit is cleaned regularly. |
| Cooling fan stays on after cooking function finishes | <ul style="list-style-type: none"> Activates to keep surfaces of the appliance cool | <ul style="list-style-type: none"> No remedy - normal operation of the appliance |

If you cannot find a solution to the problem yourself, contact your dealer or the customer service centre.

The necessary data for the customer service centre is on the rating plate on the appliance.

We recommend that you write the data at the front of this manual.

INSTALLATION



CAUTION

Do not block the air vents. If you do that, the appliance can overheat.



CAUTION

Do not connect the appliance to adapters or extension leads. This can cause overloading and risk of fire.

- Model WMB4425DSC is for built-in use only.
- The fitted cabinet must not have a back wall behind the appliance.
- Put the appliance far away from steam, hot air and water splashes.
- If the appliance is stored/ transported at sub-zero temperatures, do not activate it immediately after installation. Allow at least two hours for it to be brought up to room temperature before turning on the unit.

Installation - Built-in model WMB4425DSC

For the best integration within a kitchen, install this appliance in a standard 600mm wide cupboard that gives a flush fit with the surrounding cupboard fronts. A recess of 20mm is ideal.

The built-in cabinet must not have a rear wall behind the appliance. Do not cover ventilation slots and air intake points.

NOTE: Your appliance must be mounted on a flat surface for the full width and depth of the product.

Built-in furniture - flush fit

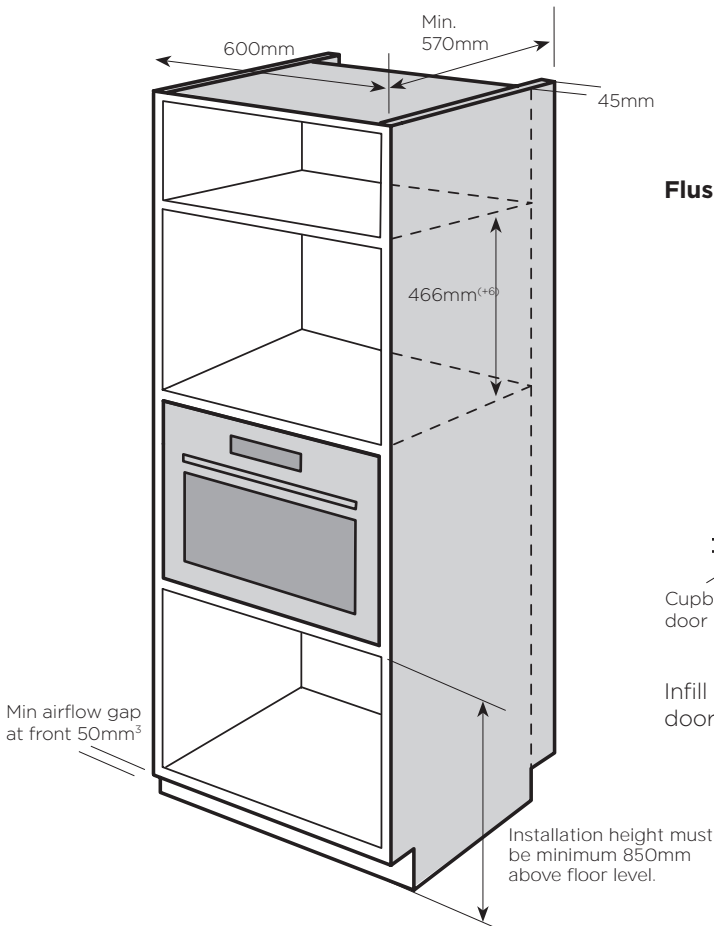

A 45mm ventilation gap must be left between the built-in cabinetry and wall with no back panelling on the cabinet housing the microwave oven. A minimum ventilation gap of 3.5mm must be left between the bottom of the front trim and adjacent shelf/cupboard.

Failure to accommodate for this gap in the installation can cause product malfunctions which are not covered under warranty

Side view

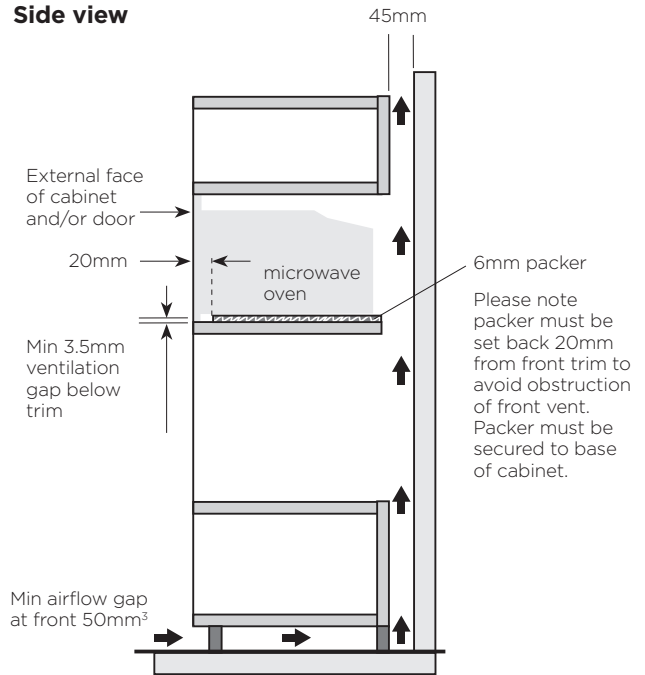

Flush fit top view

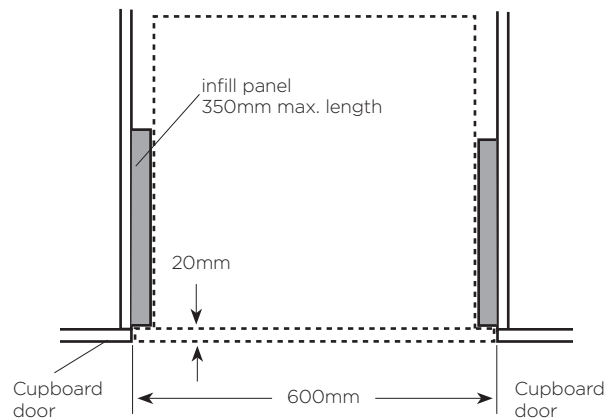

Infill panels are recessed 20mm from the external cabinet door to accommodate flush fit.

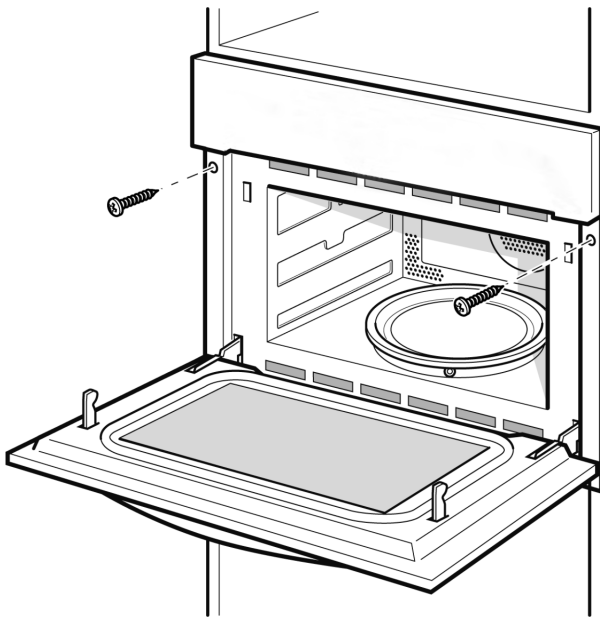

CAUTION

Do not hold or carry the appliance by the door handle. The door handle is not designed to hold the weight of the appliance and can be damaged.

1. Fully insert the appliance and center it in the cabinetry. Do not kink the connecting cable.
2. Screw the appliance into place.
3. The gap between the worktop and the appliance must not be closed by additional battens.

Specifications

| | |
|---------------------------------|-------------------------|
| Model: | WMB4425SC WMB4425DSC |
| Rated Voltage | 230-240V-50Hz |
| Rated Input Power (Microwave) | 1650W |
| Rated Output Power (Microwave) | 900W |
| Rated Input Power (Grill) | 1750W |
| Rated Input Power (Convection) | 1750W |
| Rated Input Power (Combination) | 3350W |
| Turntable Diameter | 360mm |
| External Dimensions (HxWxD) | 454 x 595 x 568mm |
| Net Weight | Approx. 36 kg |

CAUTION

Do not block the air vents. If you do, the appliance can overheat.

CAUTION

Do not connect the appliance to adapters or extension leads. This can cause overloading and risk of fire.

This appliance comes with a supply cord but no plug. Electrical connection must be made by a qualified electrician.

As stated in the local municipal building codes and other relevant statutory regulations.

- Wiring connections must be in accordance with AS/NZS 3000 Wiring Rules and any particular conditions of the local authority.
- Refer to data plate for rating information and circuit diagram. The data plate is positioned behind the bottom of the oven door. The circuit diagram is positioned on the top panel of the appliance.
- For appliances with open cooking surfaces, an all pole disconnect functional switch should be provided near the appliance in an accessible position. Refer to AS/NZS 3000 clause 4.7.1.
- Wiring should be protected against mechanical failure. Refer to AS/NZS3000 clauses 3.3.2.6, 3.9, 3.10.
- A means of disconnection with a contact separation of at least 3mm must be supplied in the fixed wiring.

WARNING

This appliance must be properly earthed.

- Do not lift the appliance by the door handle.
- Prepare the cupboard opening to match your appliance measurements. (See diagrams).
- Slide appliance into the cupboard, ensuring that the supply cable (where fitted) does not kink.
- To prevent tipping, use the screws supplied to secure your oven into the cupboard. Use just 2 screws for single cavity ovens.
- If the supply cord is damaged, it must be replaced by the manufacturer or its service agent or similarly qualified person in order to avoid a hazard.
- Where the appliance is built into a cabinet, the cabinet material must be capable of withstanding 70°C. Installation into low temperature tolerant cabinetry (eg. vinyl coated) may result in deterioration of the coating by discolouring or bubbling.
- If the appliance is installed adjacent to vinyl-wrapped surfaces, use an installation kit available from the vinyl wrap supplier.

INSTALLATION (CONTINUED)

- Electrolux Home Products cannot accept responsibility for damage caused by installation into low temperature tolerant cabinets.
- After installation, test and ensure that the appliance operates correctly before handing it over to the customer.

To avoid any potential hazard, you must follow our instructions when you install your appliance. Failure to install the appliance correctly could invalidate any warranty or liability claims and lead to prosecution.

- Put the appliance far away from steam, hot air and water splashes.
- If the appliance is stored/ transported at sub-zero temperatures, do not activate it immediately after installation. Allow at least two hours for it to be brought up to room temperature before turning on the unit.

Blocking the intake or outlet vents can damage the oven. If air vents are blocked during operation, the oven may overheat, and this may lead to malfunctioning. Hot air escapes from the vents, so be sure not to obstruct it or let curtains come between the oven and the rear wall.

- Place the oven as far away from radios and TV as possible. Operation of the oven may cause interference to your radio or TV reception.
- When there is interference, it may be reduced or eliminated by taking the following measures:
 - Clean door and sealing surface of the microwave oven.
 - Reorient the receiving antenna of the radio and/or television.
 - Move the microwave oven away from the receiver.
 - Plug the microwave oven into a different outlet so that microwave oven and receiver are on different branch circuits.
- Be sure the voltage and frequency where you connect the microwave oven is the same as specified on the rating plate on the microwave oven. If the microwave oven is connected to the socket via an extension cord, make sure the cord is earthed.



WARNING

This microwave oven must not be used on a non-earth protected power supply. Contact an electrician if you are uncertain regarding electrical connection of the oven or provision of earth protection of the supply.



WARNING

If the power cord is damaged, it must be replaced by the manufacturer, its service agent or similarly qualified persons in order to avoid a hazard.

ELECTRICAL INSTALLATION



WARNING

Only a qualified person must do the electrical installation.



IMPORTANT

The manufacturer is not responsible if you do not follow the safety precautions from the chapter "Safety Instructions".

This appliance is supplied with a supply cable only.



WARNING

The electrical installation must have an isolation device which lets you disconnect the appliance from the mains at all poles. The isolation device must have a contact opening width of minimum 3mm.

This document sets out the terms and conditions of the product warranties for Westinghouse Appliances. It is an important document. Please keep it with your proof of purchase documents in a safe place for future reference should there be a manufacturing defect in your Appliance. This warranty is in addition to other rights you may have under the Australian Consumer Law.

1. In this warranty:

- (a) 'ACL' or 'Australian Consumer Law' means Schedule 2 to the Competition and Consumer Act 2010;
- (b) 'Appliance' means any Electrolux product purchased by you and accompanied by this document;
- (c) 'ASC' means Electrolux's authorised serviced centres;
- (d) 'Westinghouse' is the brand controlled by Electrolux Home Products Pty Ltd of 163 O'Riordan Street, Mascot NSW 2020, ABN 51 004 762 341 in respect of Appliances purchased in Australia and Electrolux (NZ) Limited (collectively "Electrolux") of 3-5 Niall Burgess Road, Mount Wellington, in respect of Appliances purchased in New Zealand;
- (e) 'Warranty Period' means the period specified in clause 3 of this warranty;
- (f) 'you' means the purchaser of the Appliance not having purchased the Appliance for re-sale, and 'your' has a corresponding meaning.

2. Application: This warranty only applies to new Appliances, purchased and used in Australia or New Zealand and is in addition to (and does not exclude, restrict, or modify in any way) other rights and remedies under a law to which the Appliances or services relate, including any non-excludable statutory guarantees in Australia and New Zealand.

3. Warranty Period: Subject to these terms and conditions, this warranty continues for in Australia for a period of 24 months and in New Zealand for a period of 24 months, following the date of original purchase of the Appliance.

4. Repair or replace warranty: During the Warranty Period, Electrolux or its ASC will, at no extra charge if your Appliance is readily accessible for service, without special equipment and subject to these terms and conditions, repair or replace any parts which it considers to be defective. Electrolux may, in its absolute discretion, choose whether the remedy offered for a valid warranty claim is repair or replacement. Electrolux or its ASC may use refurbished parts to repair your Appliance. You agree that any replaced Appliances or parts become the property of Electrolux.

5. Travel and transportation costs: Subject to clause 7, Electrolux will bear the reasonable cost of transportation, travel and delivery of the Appliance to and from Electrolux or its ASC. Travel and transportation will be arranged by Electrolux as part of any valid warranty claim.

6. Proof of purchase is required before you can make a claim under this warranty.

7. Exclusions: You may not make a claim under this warranty unless the defect claimed is due to faulty or defective parts or workmanship. This warranty does not cover:

- (a) light globes, batteries, filters or similar perishable parts;
- (b) parts and Appliances not supplied by Electrolux;

- (c) cosmetic damage which does not affect the operation of the Appliance;
- (d) damage to the Appliance caused by:
 - (i) negligence or accident;
 - (ii) misuse or abuse, including failure to properly maintain or service;
 - (iii) improper, negligent or faulty servicing or repair works done by anyone other than an Electrolux authorised repairer or ASC;
 - (iv) normal wear and tear;
 - (v) power surges, electrical storm damage or incorrect power supply;
 - (vi) incomplete or improper installation;
 - (vii) incorrect, improper or inappropriate operation;
 - (viii) insect or vermin infestation;
 - (ix) failure to comply with any additional instructions supplied with the Appliance;

In addition, Electrolux is not liable under this warranty if:

- (a) the Appliance has been, or Electrolux reasonably believes that the Appliance has been, used for purposes other than those for which the Appliance was intended, including where the Appliance has been used for any non-domestic purpose;
- (b) the Appliance is modified without authority from Electrolux in writing;
- (c) the Appliance's serial number or warranty seal has been removed or defaced.

8. How to claim under this warranty: To enquire about claiming under this warranty, please follow these steps:

- (a) carefully check the operating instructions, user manual and the terms of this warranty;
- (b) have the model and serial number of the Appliance available;
- (c) have the proof of purchase (e.g. an invoice) available;
- (d) telephone the numbers shown below.

9. Australia: For Appliances and services provided by Electrolux in Australia: Electrolux goods come with guarantees that cannot be excluded under the Australian Consumer Law. You are entitled to a replacement or refund for a major failure and for compensation for any other reasonably foreseeable loss or damage. You are also entitled to have the Appliance repaired or replaced if the Appliance fails to be of acceptable quality and the failure does not amount to a major failure. 'Acceptable quality' and 'major failure' have the same meaning as referred to in the ACL.

10. New Zealand: For Appliances and services provided by Electrolux in New Zealand, the Appliances come with a guarantee by Electrolux pursuant to the provisions of the Consumer Guarantees Act, the Sale of Goods Act and the Fair Trading Act. Where the Appliance was purchased in New Zealand for commercial purposes the Consumer Guarantee Act does not apply.

11. Confidentiality: You accept that if you make a warranty claim, Electrolux and its agents including ASC may exchange information in relation to you to enable Electrolux to meet its obligations under this warranty.

Important Notice

Before calling for service, please ensure that the steps listed in clause 8 above have been followed.

| | | |
|--------------------|--|---|
| AUSTRALIA | FOR SERVICE or to find the address of your nearest authorised service centre in Australia PLEASE CALL 13 13 49 For the cost of a local call | FOR SPARE PARTS or to find the address of your nearest spare parts centre in Australia PLEASE CALL 13 13 50 For the cost of a local call |
| NEW ZEALAND | FOR SERVICE or to find the address of your nearest authorised service centre in New Zealand PLEASE CALL 0800 10 66 10 | FOR SPARE PARTS or to find the address of your nearest spare parts centre in New Zealand PLEASE CALL 0800 10 66 20 |

For more information on all Westinghouse appliances, or for dimension and installation information, call into your retailer, phone or email our customer care team or visit our website:

AUSTRALIA

phone: 13 13 49

email: customercare@electrolux.com.au

web: westinghouse.com.au

NEW ZEALAND

phone: 0800 10 66 10

email: customercare@electrolux.co.nz

web: westinghouse.co.nz

**Westinghouse. We are part of the Electrolux family.
Share more of our thinking at www.electrolux.com**

 and WESTINGHOUSE are trademarks of Westinghouse Electric Corporation.
Used under license. All Rights Reserved.

© 2019 Electrolux Home Products Pty Ltd.
ABN 51 004 762 341
WMAN_Microwave_WMB4425DSC_Mar22

PN:16170000A75443