

**Enjoy peace of mind.
Register your appliance today.**

Stay updated on better living services, safety notices and shop for accessories.

- 1. Open the camera app on your smartphone and point at the QR code to scan**
Product Registration QR code is located on the front of your appliance or inside the door rim*.

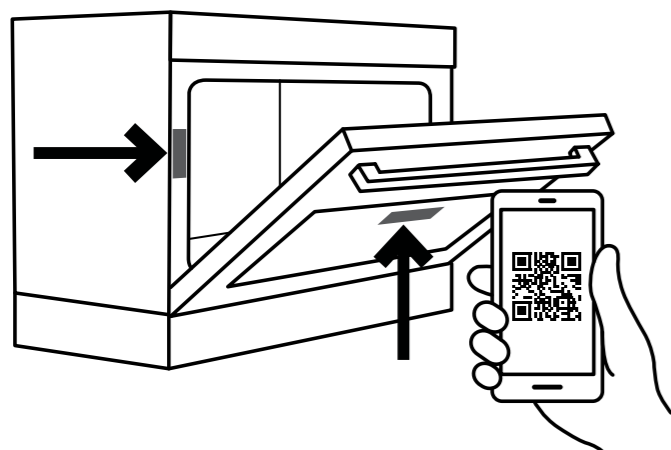

- 2. Tap the notification or link to open the registration form**
- 3. Complete your details and enjoy peace of mind**

*Exact location of QR code may vary depending on oven model



Need more help?

To access your detailed user manual online, simply scan the QR code on your smart phone. If you prefer a printed manual, please contact our Customer Care Centre using details below.



Contact us if you need more help

Electrolux Home Products Australia

telephone: 13 13 49
email: customercare@electrolux.com.au
web: electrolux.com.au

Electrolux Home Products New Zealand

telephone: 0800 436 245
email: customercare@electrolux.co.nz
web: electrolux.co.nz

Dear Customer,

Thank you for purchasing a Westinghouse appliance. You have chosen a product that comes from a history of durable and reliable products loved by many families. We look to help you make the most of your time at home, so you can spend your time doing what you really love, with the ones you love.

Welcome to Westinghouse.

Ready



This is a Quick Start Guide. Please refer to user manual online for detailed information and installation

To access your detailed user manual online, simply scan the QR code on your smart phone.

For more detailed information and installation guide refer to user manuals at westinghouse.com.au/manuals

Before you start, please make sure:

- Your cooker has been correctly installed by a qualified person.
- Your cooker has power and is switched on.
- You've removed all relevant packaging.



Most of the packaging materials can be recycled. Please dispose of them at your local recycling centre or in your own recycling bin.

Set...

Get to know the control panel:

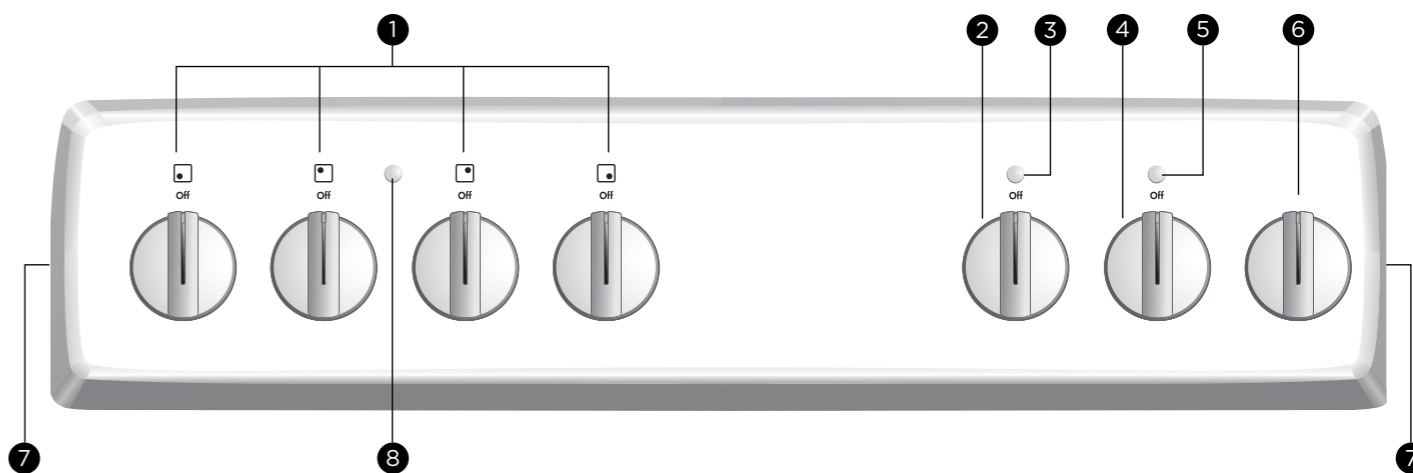

- | | | |
|-----------------------------------|--|--|
| 1 Cooktop control knob | 4 Grill temperature control knob for WLE622, WLE642 models. Function knob for WLE620, WLE624 models | 6 Timer (where fitted) |
| 2 Temperature control knob | 5 Grill indicator light for WLE622, WLE642 models | 7 Switched socket outlet (where fitted) |
| 3 Oven indicator light | | 8 Cooktop indicator light |

Set...

Installing the accessories

Fitting the oven shelves

1. Ensure shelf orientation is correct (refer to diagram below).
2. Slide oven shelves onto oven supports (side runners) at an angle until raised back of shelf is past the stop on oven supports (side runners).
3. Lower front of shelf and push in until stop is reached.
4. To remove oven shelves, withdraw to the stop and raise the front of shelf to clear the stop.

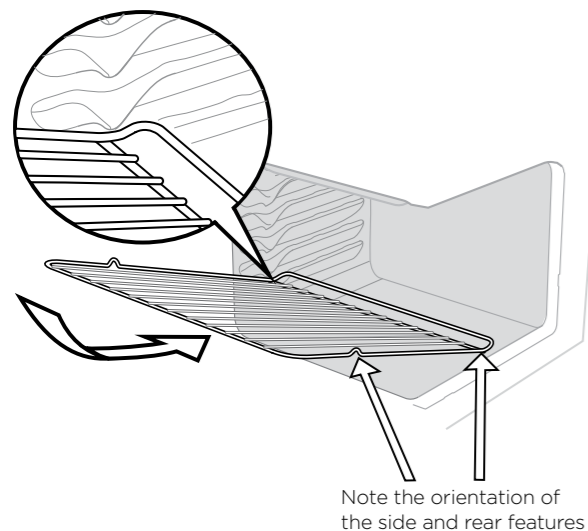

For separate grill models:

Fitting the grill dish supports

1. Insert the rear hook into the rear hole.
2. Align the front peg to the front hole and push in firmly.

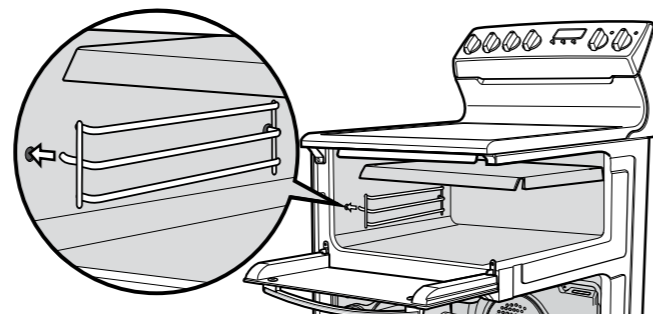

Fitting the grill dish

Ensure rear of the dish is engaged with the side support before sliding backwards. To remove, simply pull forwards and upwards.

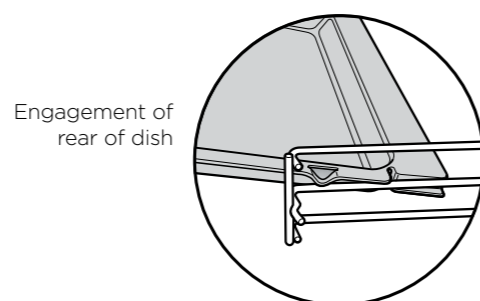

Condition the oven

(to burn off any residue)

New appliances can have oil or residue left from manufacturing. You will need to heat your oven for 30 minutes before using it for the first time.

1. Turn the function selector knob to 'Bake' for WLE620 and WLE624 models.
2. Using the temperature control knob, set the oven at 180°C for approximately 30 minutes. Please ensure that the room is well ventilated during this process.

**WLE620,
WLE624**

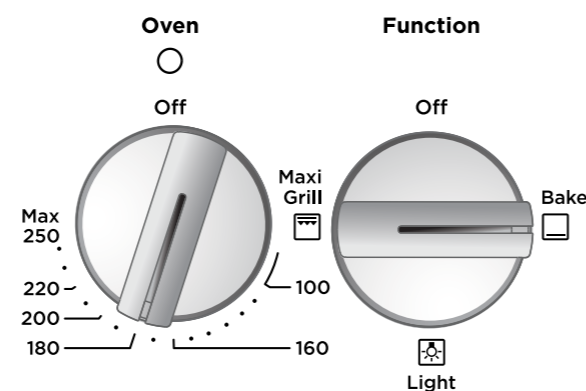

**WLE622,
WLE642**

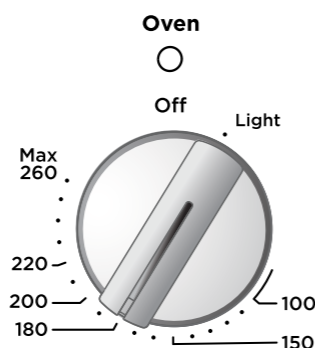

Go!

You're ready to use your new Westinghouse appliance. A few tips from us:

Remember to pre-heat each time.

For best cooking results pre-heat the oven. Pre-heating allows the oven to reach the required temperature quickly and efficiently as well as cook food at the correct temperature for the entire cook time. Recommended pre-heat time is 30 minutes for baking and 3 minutes for grilling.

Choose the right program for the best result:

RADIANT COOKTOP

(For WLE620, WLE624, WLE622)

The high-speed radiant hotplates heat rapidly from a cold start, saving you power and allowing you to start preparing your meal without fuss.

CERAMIC COOKTOP

(For WLE642)

Our range of ceramic cooktops combine stylish good looks with practical features to help you prepare delicious meals with ease and confidence. While the durable ceramic surface is tough enough to handle the everyday knocks of the busiest family kitchen, it must be remembered that the surface is made of glass and should not be treated as unbreakable.

OVEN

The oven is ideal for quick, multi-shelf cooking for family meals. It's great for keeping the air and food moist inside your oven, resulting in juicier, tastier dishes that are evenly cooked and delicious.

GRILLING - MAXI GRILL (IN OVEN)

(For WLE620, WLE624)

The 'Maxi Grill' directs radiant heat from the powerful upper grill element and the upper bake element onto the food. It is ideal for cooking tender cuts of meat, steak, chops, sausages, fish, cheese toasties and other quick cooking foods. Preheat your grill for 3 minutes to get the best results. This will help seal in the natural juices of steak, chops etc. for a better flavour. **Grill with the door open to the first stop position.**

GRILLING - SEPARATE

(For WLE622, WLE642)

The grill function is suitable for tender cuts of meat, steak, chops,sausages, fish, cheese toasties and other quick cooking foods. Preheat your grill for 3 minutes to get the best results. This will help seal in the natural juices of steak, chops etc. for a better flavour. **Grill with the grill door open.**

Refer to your full user manual for more details on oven functions.

Set your temperature

- To set the temperature, turn the temperature control knob in a clockwise direction to the desired setting.
- An indicator light in the display will turn on and the grill/oven will begin to heat.
- Once the food is cooked, turn the temperature control knob back in an anti-clockwise direction to the 'Off' position.

Note: For WLE620 and WLE624 models the desired cooking function must be selected before the oven will turn on. The oven indicator light cycles on and off to maintain the required temperature in the oven.

Set a Timer (where fitted)

- To set the timer, simply turn the knob clockwise to the required number of minutes.

NOTE: For any time below 10 minutes, turn the knob past the 30 minute mark, then turn it back to the required number of minutes.