

USER MANUAL

Ice + Water French Door Models



Westinghouse

CONGRATULATIONS

Congratulations and thank you for choosing our refrigerator/freezer. We are sure you will find your new appliance a pleasure to use. Before you use the appliance, we recommend that you read through the relevant sections of this manual, which provides a description of your appliance and its functions.

To avoid the risks that are always present when you use an electric appliance, it is important that the appliance is installed correctly and that you read the safety instructions carefully to avoid misuse and hazards.

We recommend that you keep this instruction booklet for future reference and pass it on to any future owners.

After unpacking the appliance, please check it is not damaged. If in doubt, do not use the appliance but contact your local customer care centre.

The symbols you will see in this booklet have these meanings:



WARNING

This symbol indicates information concerning your personal safety



CAUTION

This symbol indicates information on how to avoid damaging the refrigerator



TIPS & INFORMATION

This symbol indicates tips and information about use of the refrigerator



ENVIRONMENTAL TIPS

This symbol indicates tips and information about economical and ecological use of the refrigerator

CONDITIONS OF USE

This appliance is intended to be used in household and similar applications such as:

- Staff kitchen areas in shops, offices and other working environments
- Farm Houses
- By clients in hotels, motels, and other residential type environments
- Bed and Breakfast type environments

Record model and serial number here:

Model: _____

Serial No: _____

CONTENTS

Important safety instructions	3
General warnings	4
WHE5160 features	5
Installing your new appliance	6
Ventilation around your appliance.	6
Installing your refrigerator	6
Fitting the handles.	7
Initial start-up	8
Ice + water installation	9
Using your electronic controls	13
Controlling the temperature.	13
Changing the freezer temperature.	13
Changing the refrigerator temperature	13
Quick freeze function	13
Freezer temperature alarm	13
Door alarm.	14
Display Lock	14
Drinks chill timer	14
Energy efficiency	14
Eco mode	14
Normal mode	14
Holiday mode	14
Other features	15
Using your refrigerator	16
SpillSafe™ glass shelves	16
Wine Rack.	16
Door storage bins.	16
Dairy compartment	16
Crisper bin	16
Freezer Bins	17
Care and maintenance	18
LED lightingb	18
Cleaning the appliance	18
Troubleshooting	19
Ice + water troubleshooting	20
Warranty	23

IMPORTANT SAFETY INSTRUCTIONS

Please read the user manual carefully and store in a handy place for later reference. Pass the user manual on to new owners of the refrigerator.



TIPS & INFORMATION

IMPORTANT – CHECK FOR ANY DAMAGES OR MARKS

If you find the refrigerator is damaged or marked, you must report it within 7 days if you wish to claim for damage/marks under the manufacturer's warranty. This does not affect your statutory rights.



ENVIRONMENTAL TIPS

INFORMATION ON DISPOSAL FOR USERS

- Most of the packing materials are recyclable. Please dispose of those materials through your local recycling depot or by placing them in appropriate collection containers.
- If you wish to discard this product, please contact your local authorities and ask for the correct method of disposal.



WARNING

- When you dispose of your old refrigerators and freezers, remove any doors. Children can suffocate if they get trapped inside.
- This appliance is not intended for use by persons (including children) with reduced physical, sensory or mental capabilities, or lack of experience and knowledge, unless they have been given supervision or instruction concerning use of the appliance by a person responsible for their safety. Children should be supervised to ensure that they do not play with the appliance.
- Don't use a steam cleaner. If live components come into contact with condensing steam, they may short-circuit or cause an electric shock.
- Do not use mechanical devices or other means to accelerate the defrosting process other than those recommended by the manufacturer.
- This appliance contains insulation formed with flammable blowing gases. Avoid safety hazards by carefully disposing of this appliance.
- If pressurised aerosol containers bear the word 'flammable' and/or a small flame symbol, do not store them inside any refrigerator or freezer. If you do so you may cause an explosion.



R600a refrigerant warning

- This appliance contains flammable R600a refrigerant. Avoid safety hazards by carefully installing, handling, servicing and disposing of this appliance. The details of the refrigerator are indicated on the rating plate inside the appliance.
- Ensure that the tubing of the refrigerant circuit is not damaged during transportation and installation.
- In the event any damage accidentally occurs, keep the appliance away from open fires and any devices that produce sparks or arcs and luminaries during normal or abnormal operation, and unplug the appliance at the power point. Call authorised service for necessary action and advice.
- Leaking refrigerant may ignite vent area if leak occurs.
- The room for installing appliance must be at least 1 m³ per 8g of refrigerant. The amount of R600a refrigerant in the appliance can be found on the rating plate inside the appliance.
- In Queensland the authorised service person MUST hold a gas work authorisation for hydrocarbon refrigerants to carry out servicing or repairs which involve the removal of covers.
- Do not damage the refrigerant circuit.
- Do not use electrical appliances inside the food storage compartments of the appliance, unless they are of the type recommended by the manufacturer.



WARNING

It is hazardous for anyone other than an authorised service person to service this appliance. In Queensland the authorised service person MUST hold a gas work authorisation for hydrocarbon refrigerants to carry out servicing or repairs which involve the removal of covers.















GENERAL WARNINGS







Read the following carefully to avoid damage or injury

 **THIS SYMBOL INDICATES NEVER TO DO THIS**





 **THIS SYMBOL INDICATES ALWAYS DO THIS**

It is important to use your refrigerator safely. Check these safety points before using your refrigerator.

-  The appliance must be plugged into its own dedicated 220-240V, 50Hz AC electrical outlet.
-  The plug must be accessible when the refrigerator is in position.
-  It is essential the power point is properly earthed to ground. Consult a qualified electrician if you are unsure.
-  Don't use extension cords or adapter plugs with this refrigerator.
-  If the power supply cord is damaged, it must be replaced by the manufacturer, its service agent or similarly qualified persons in order to avoid a hazard.
-  Unplug the appliance before cleaning and before changing the light bulb to avoid electric shock.
-  Never unplug the refrigerator by pulling the electrical cord as this may damage it. Grip the plug firmly and pull straight out.
-  Choose a location for your refrigerator that isn't too cold. The ambient room temperature should be above 10°C.
-  Stand your refrigerator in a dry place – avoid areas of high moisture or humidity.
-  Do not put the refrigerator in frosty or unprotected areas like a garage or on the verandah.
-  Do not plug your refrigerator into a timer fitted to the power point.
-  Do not put the refrigerator in direct sunlight, near stoves, fires or heaters.
-  Do not put the refrigerator on an uneven surface.
-  Do not store flammable materials on or under the appliance, e.g. aerosols.
-  Do not store explosive substances, such as aerosol cans with a flammable propellant, in this appliance.

-  Never store fizzy drinks in the freezer compartment.
-  Never try to repair the refrigerator yourself, only use a qualified or authorised service person for repairs.
-  Never use electric heaters or dryers to defrost the freezer because you can receive an electric shock.
-  When transporting and installing the refrigerator, care should be taken to ensure that no parts of the refrigerating circuit are damaged.
-  Keep ventilation openings in the appliance enclosure or in the built-in structure clear of obstruction.
-  When installed correctly, your refrigerator should:
 - Have adequate space at the back and sides for air circulation (refer to page 5).
 - Be vertically aligned to the surrounding cupboards.
 - Have doors that will self-close from a partially open position.

For Ice & Water models only

-  Check for water leaks at all water connection points in the first two or three hours after installation. Re-check after 24 hours to ensure connection is watertight. If the connection is leaking, contact a licensed plumber.
-  Do not use with water that is microbiologically unsafe or with water of unknown quality without adequate disinfection.
-  Never connect the appliance to a hot water supply.
-  Never install the water filter in an area of the wall where there may be electrical wires and/or water supply pipes.
-  Never install the water filter in an area of direct sunlight.

NOTE: You must read these warnings carefully before installing or using the refrigerator. If you need assistance, contact your Customer Care Department. The manufacturer will not accept liability, should these instructions or any other safety instructions incorporated in this book be ignored.

WHE5160 FEATURES

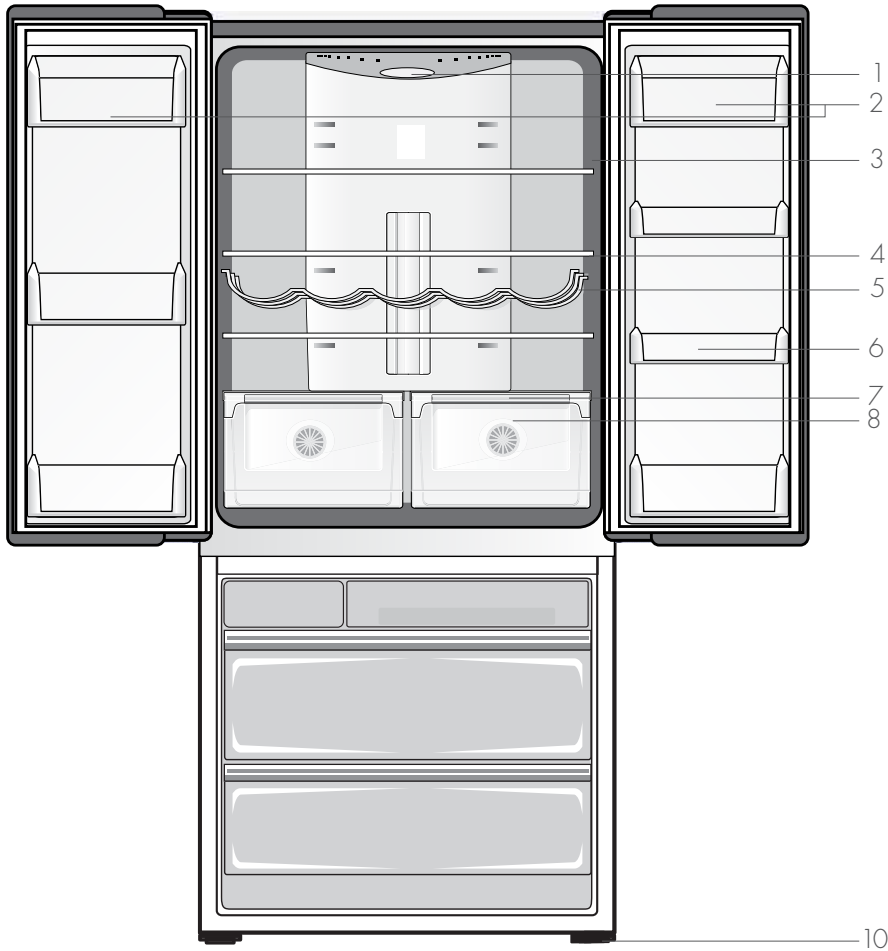

Electronic controls

- 1 Refrigerator light
- 2 Twin dairy compartments
- 3 Electronic temperature controls
- 4 Adjustable glass shelves
- 5 Bottle/wine rack
- 6 Adjustable door bins
- 7 Humidity controls
- 8 Crisper bins on telescopic slides
- 9 Egg Tray (not shown)
- 10 Adjustable rollers

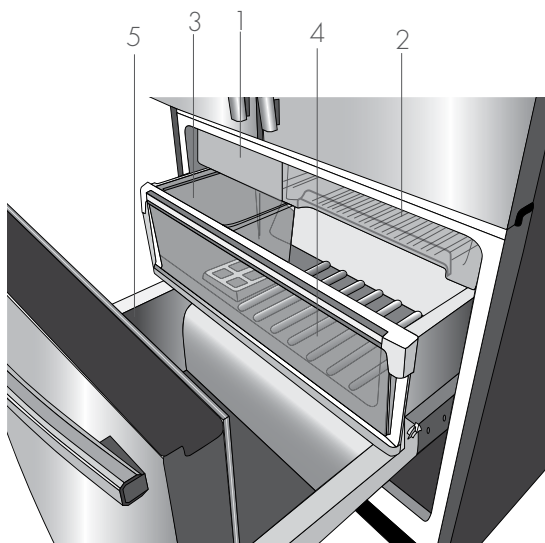

- 1 Icemaker assembly
- 2 Freezer storage tray
- 3 Ice bin with scoop (inside freezer drawer)
- 4 Top freezer drawer on telescopic extension slides
- 5 Removable bottom freezer drawer mounted on pull out freezer door

INSTALLING YOUR NEW APPLIANCE

Adequate ventilation around your refrigerator.

The diagram below shows the recommended airspace to allow for ventilation of your refrigerator.

If 5 mm side clearance, the fridge cabinet must sit at least 5mm proud of kitchen cabinetry for doors to open. A 5 mm side clearance requires 50 mm rear clearance and 50–90mm clearance above. If you don't have a cupboard with a rear gap, the recommended clearance area on top increases from 50mm to 72mm (x) and from 32mm to 90mm (y). When positioned in a corner area, spacing of at least 300mm on the sides will allow the doors to open enough to enable the removal of bins and shelves.

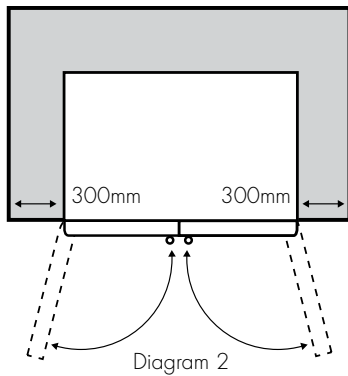
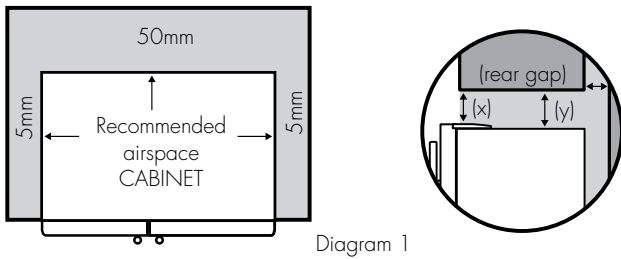

NOTE: Doors are designed to sit proud of cabinetry (not flush). The clearances shown above are the recommended minimum clearances. The clearance at the rear must not exceed 75mm.

Installing your refrigerator

Your new refrigerator should arrive with the front adjustable rollers wound down, to tilt the top backwards by about 10mm from upright. This will allow your freezer drawer to self-close, providing a consistent closed seal.

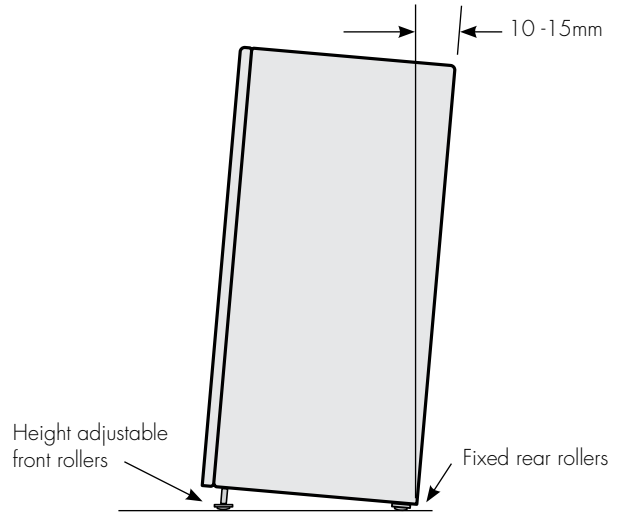

CAUTION

The rollers are designed for forward or backward movement only. They are not castors. Moving the refrigerator sideways may damage your floor and the rollers.

1. Roll the refrigerator into place.
2. If the refrigerator isn't tilted back, you can adjust the two front rollers by turning the large, plastic roller nut. (see diagram below). One turn of the nut increases the height of the refrigerator by 10mm. If you have difficulty turning the roller nut, have someone tilt the refrigerator back, so you have better access. Alternatively, you can access the rollers from the side, using a flat screwdriver. (See diagram below).

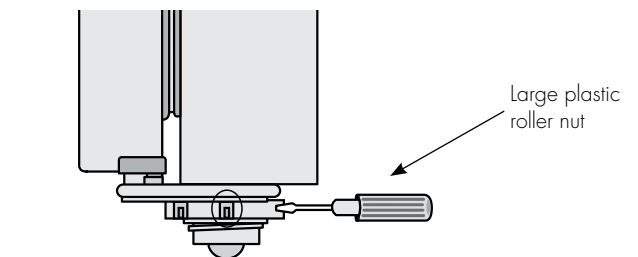

3. Check the alignment of the refrigerator to the surrounding cupboards to see if it is level. You can adjust the level with the rollers as detailed in step 3.

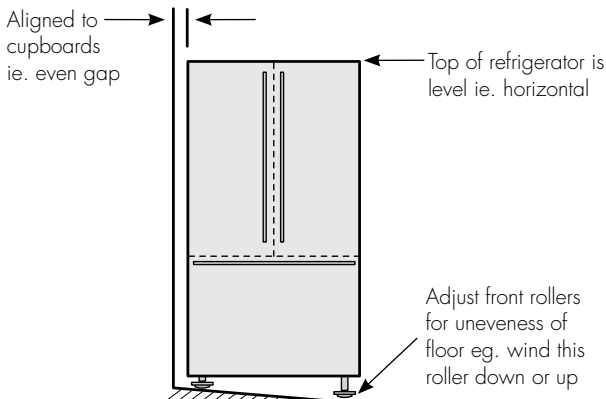

4. If you find your refrigerator rocks from corner to corner, it means your floor is uneven. Find a piece of plastic or hardboard etc. and pack it firmly under the roller.
5. On certain floor surfaces the refrigerator may roll forward during operation. A "Roller Stop", which is provided, can be placed under the front rollers.

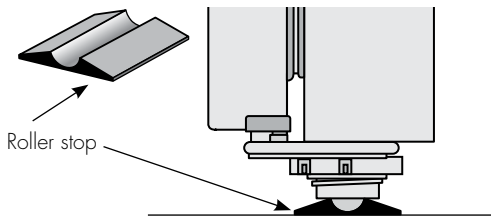

6. You may now need to fine-tune the installation by repeating Steps 3, 4 and 5.

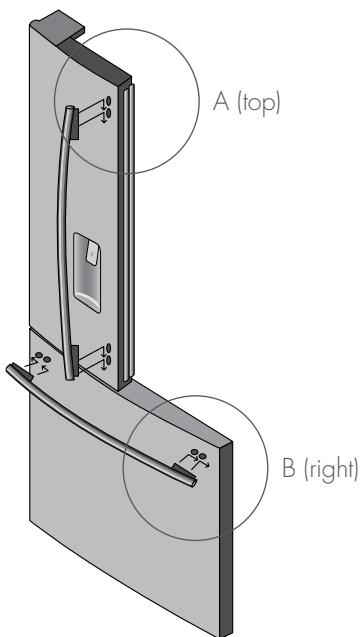

FITTING THE HANDLES

1. Remove the handles from the packaging
2. Fit the refrigerator handle by aligning the handle with the mounting locations on the door (as shown below in illustration A). Ensure that the handle end marked "TOP" is aligned with the top mounting location on the door.
3. Pull the handle down until you hear a "click"
4. Repeat this with the other refrigerator handle.

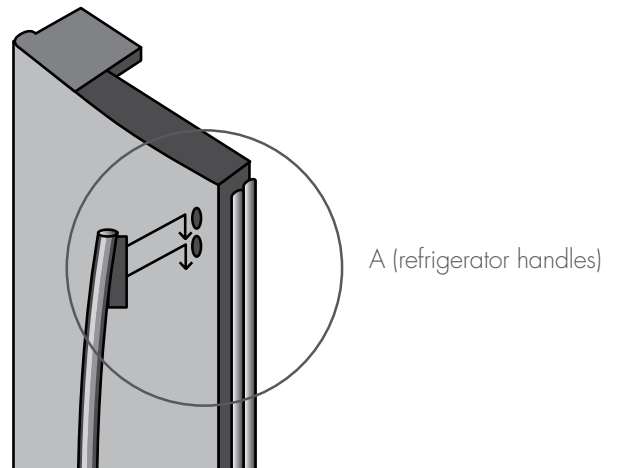

5. Next, fit the freezer handle (B). (model WHE5100 only)

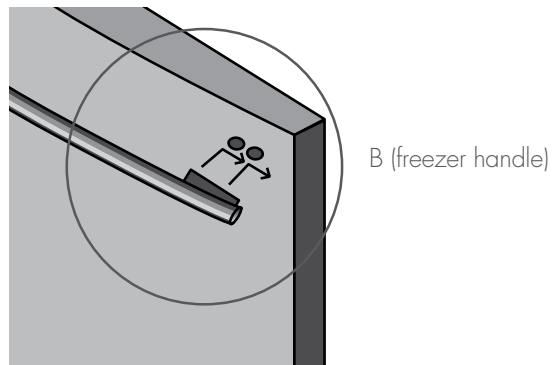

6. Align the freezer handle with the mounting location on the freezer door, ensuring that the end marked "Right" is aligned with the mounting location on the right side of the door.
7. Pull the handle to the left until you hear a "click"
8. Clean your refrigerator thoroughly following the instructions on page 15 and wipe off any dust that has accumulated during shipping.
9. Plug your refrigerator straight into its own power point and never use a double adapter.
10. Before you put any food in your refrigerator, it is recommended you leave it on for 2 or 3 hours to check it is running properly and the appropriate temperature is reached.

INITIAL START-UP

Congratulations! You have successfully installed your new refrigerator.

Refrigerators work by transferring heat from the food inside to the outside air. This operation makes the back and sides of the refrigerator (particularly at start-up) feel warm – which is normal.

A cooling coil is located behind the rear wall of the freezer section. This coil cools and removes moisture from the air inside.

Avoid placing food against the air vents in the refrigerator, as it affects the efficient circulation. If the door is opened frequently, a light frosting will occasionally occur on the freezer's interior. This is normal and will clear after a few days. If the freezer door is accidentally kept open, a heavy frost will coat the inside walls and should be removed.

Your new refrigerator uses a high-speed compressor, along with other energy-efficient components, which may make unusual sounds. These sounds simply indicate your refrigerator is working how it should. They include:

- Compressor running noises;
- Air movement noise from the small fan motor;
- A gurgling sound, similar to water boiling;
- A popping noise, heard during automatic defrosting;
and
- A clicking noise, prior to compressor start-up.

ICE AND WATER INSTALLATION

WARNING

Connect to potable water supply only

The external water filter kit

An external water filter and connection kit has been supplied for use with your Ice & Water refrigerator. The external filter design allows more space within the refrigerator and provides double the life of previous filters reducing the cost of replacement.

The filter is designed to significantly reduce chlorine, taste, odour, heavy metals, turbidity (cloudiness) and scale build up. The included plastic water tube allows quick connection to the filter and is designed for high durability and kink resistance.

This filter is designed only to be used with a potable water supply. It should not be used on water that is micro biologically unsafe or with water of unknown quality. The filter should be replaced every 12 months. The service life of the filter may be reduced in water supplies that contain an excess of particles or other impurities. Reduced flow rate is an indication that a new filter is required. Failure to replace the filter when required can affect the function of the ice maker. Service calls caused by a failure to replace the filter are not covered by warranty.

Contents of installation kit

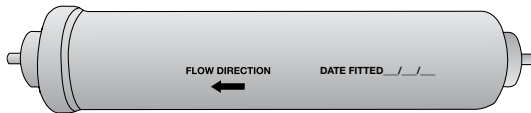

1 x water filter with push fit connections

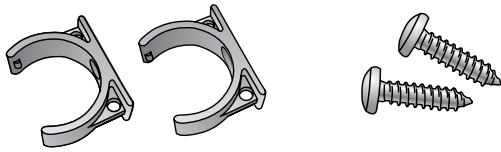

2 x mounting brackets and screws

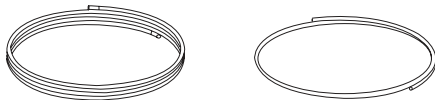

4 + 1 metres of water tubing

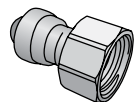

1 x 1/2" tap fitting



2 x circlips

Please read before beginning installation

The water connection to your ice and water product can be self-installed. It is recommended that you seek advice from a licensed plumber (if necessary) before commencing the installation.

CAUTION

Your warranty may be voided by an incorrect installation

Water supply and plumbing

A drinkable water supply to suit a 1/2" tap fitting is required adjacent to the refrigerator. It is recommended that a licensed plumber install a new water supply outlet nearer to the appliance should the tubing supplied not be long enough. It is not recommended that the tubing be extended as this could adversely affect the flow of water to the ice maker or water dispenser.

The water dispenser and automatic ice maker require a drinkable water supply with a pressure range of between 206kPa and 689kPa (30PSI and 100PSI). If the water supply is above 100psi a pressure limiting valve should be installed.

It is recommended that a Noise Reduction Valve also be fitted in the water supply line. This will reduce water hammer and its effects on quick action house hold taps and fast acting valves on appliances. The refrigerator water valve is pre-fitted with a push-fit connector for inserting the water tube. Where the tap connection is other than 1/2" adapters can be purchased from plumbing supply stores or good hardware stores.

Water filter

Locate the water filter as close as possible to the water supply tap in a vertical position where possible. The filter will need to be replaced every 12 months to prevent excess filtered micro-organism build-up, and thus ensure continuous purified water and ice supply for you and your family. Replacement water filters are available from Electrolux Home Products Spare Parts Centres and can be posted to you for your convenience (refer to back page for contact details).

CAUTION

If the appliance is not connected to a water supply ensure that the ice maker is switched off (refer to STEP 1 overleaf). If you don't do this a loud buzzing noise will be heard intermittently. The new hose-sets supplied with the appliance must be used and old hose-sets should not be reused. Do not use with water that is microbiologically unsafe or with water of unknown quality without adequate disinfection. Never connect the appliance to a hot water supply. Never install the water filter in an area of the wall where there may be electrical wires and / or water supply pipes.

ICE AND WATER INSTALLATION

Never install the water filter in an area of direct sunlight. Check for water leaks at all water connection points in the first 2 to 3 hours after installation, and correct it in case of any water leak. Recheck after 24 hours; if leak still occurs, it is recommended to contact a licensed plumber for advice.

Water is to be connected as per diagram below.

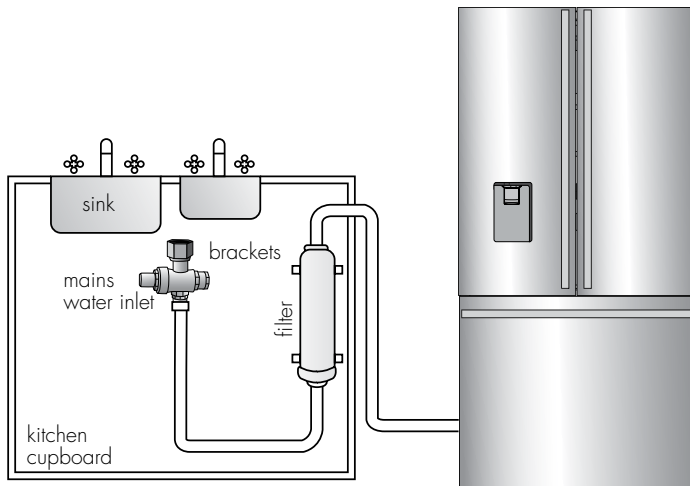

Step 1.
Ensure that the ice maker and water dispenser are switched OFF

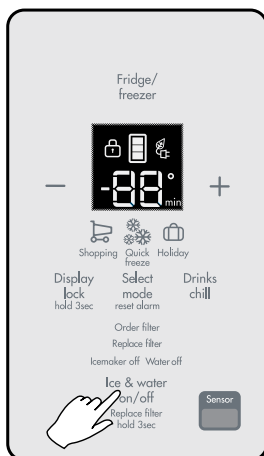

Step 2.
Disconnect refrigerator from power supply.

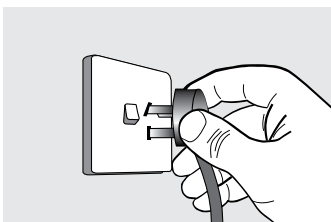

Step 3.
Connect tap fitting to water supply tap. Tap must be close to the refrigerator.

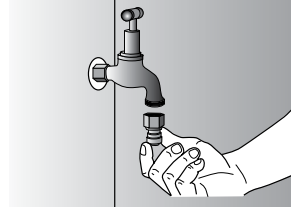

Step 4.
Install brackets for filter close to tap. Plan to leave as much tubing as possible behind the refrigerator to enable it to be moved easily for cleaning or service.

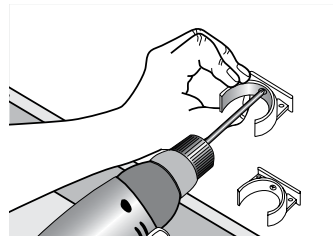

CAUTION

Do not screw the brackets into the refrigerator as this may void your warranty and permanently damage the refrigerator.

Step 5.
Write date on filter. The filter will need to be replaced every 12 months.

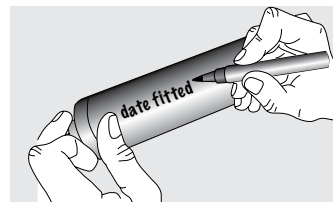

Step 6.
Extend the collar and clip a circlip around the collar at both ends of the filter.

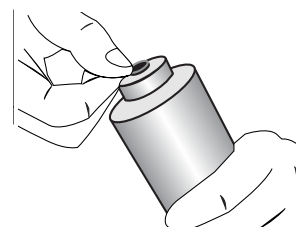

ICE AND WATER INSTALLATION

Step 7.
Fit filter to brackets with water flow arrow pointing up.

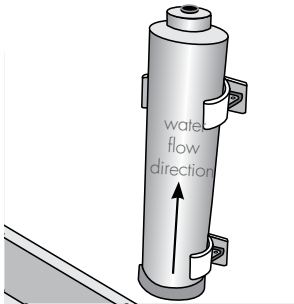

Step 8.
Push shorter tube into tap fitting past insertion mark.

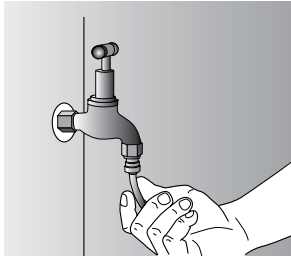

Step 9.
Push other end into filter INLET.

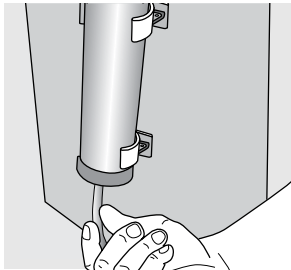

Step 10.
Connect remaining tube length into filter OUTLET.

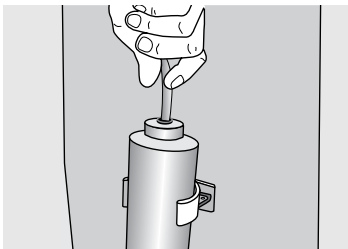

Step 11.
Connect other end of remaining tube length to inlet on bottom right hand side of refrigerator.

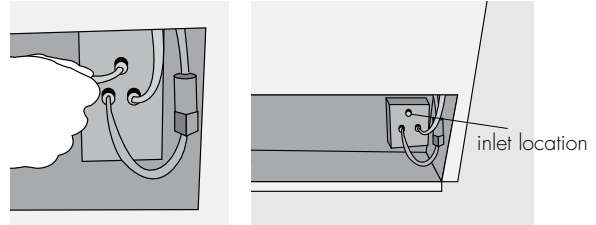

Step 12.
Turn on water and check all joints and tubes for leaks.

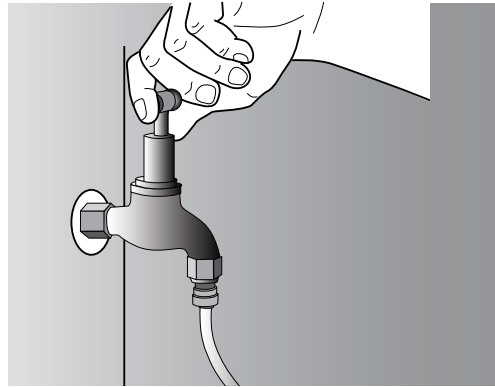

Step 13.
Reconnect the power.

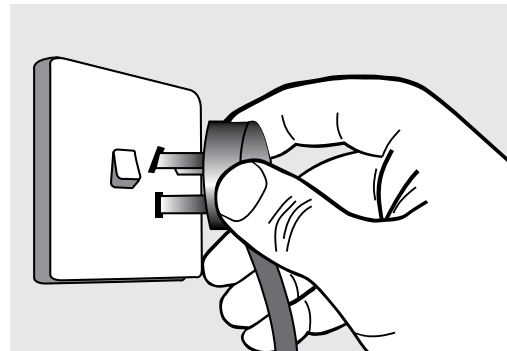

Step 14.
Move the refrigerator back into place being careful not to kink or split the tubing.

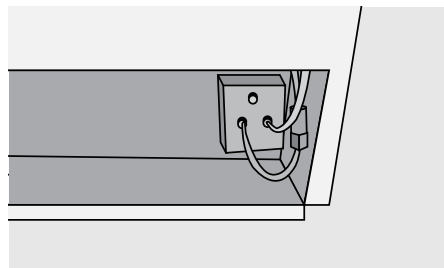

ICE AND WATER INSTALLATION

Step 15.

Using a large container run the water dispenser to clear air from lines. This may take a few minutes. Purge and dispense a minimum of 2 litres of water. Initial water may be black in colour. This is residual carbon dust from the filter and is non-toxic. If the water is slow to shut off or the dispenser is dripping, air may still be in the lines. Either purge more water through the system to remove this air or allow some time for the air to be removed over subsequent dispensing.

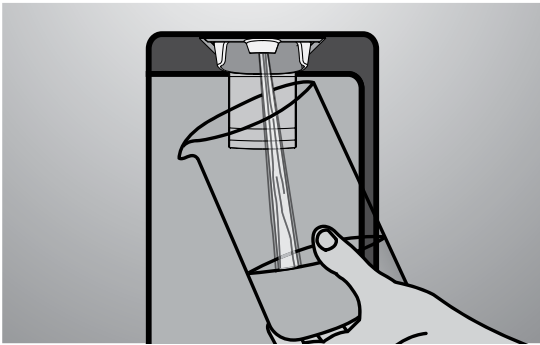

Step 16.

Switch ON Ice Maker.

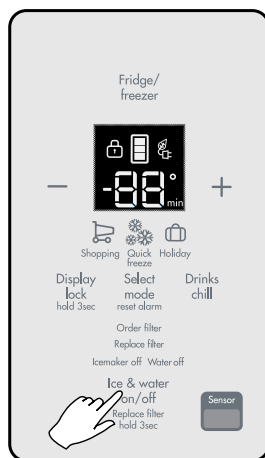

Step 17.

After 24 hours remove ice bin and dispose of first few batches of ice to ensure that impurities have been flushed from the system.

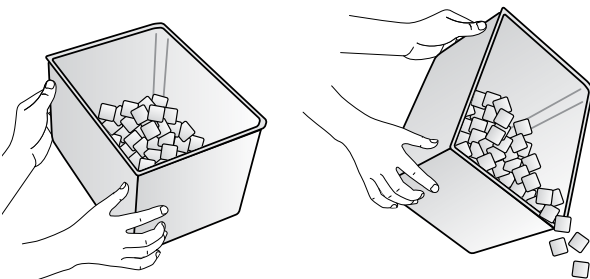

Tips and useful information

- ✔ Ensure that taps are turned off when replacing and fitting filters. Remember to turn the taps back on when filter fitting is complete.
- ✔ Always fit filter as per manufacturer's instructions, paying special attention to water flow direction.
- ✔ If you need to replace water tube, only use approved water quality piping that meets the pressure requirements.
- ✘ Do not allow the water tubing to become kinked or trapped under the refrigerator when moving the refrigerator back into position.
- ✔ Make sure your refrigerator is level to avoid uneven ice cubes.
- ✔ After installation, run the water dispenser for a few minutes to remove carbon dust and to ensure that all air bubbles have been purged from the tubing. Dripping may occur if air bubbles remain in the tube.
- ✔ Replace filter at suggested intervals to avoid water/ice reduction and irregularities in taste.
- ✔ Remove and clean ice bin once a month, discarding unused ice cubes. This will ensure fresh, clean ice and smooth operation of your ice maker.
- ✔ Clean and empty the dispenser drip tray regularly to avoid overflow.
- ✔ As the water cut off is not instant, leave glass under dispenser briefly until water has stopped flowing to avoid spills.

CAUTION

If you have not used the dispenser for some time discard the first seven or eight cups of water and any ice that the ice maker produces in the first 24 hours (contaminants could have settled in the water pipes).

USING YOUR ELECTRONIC CONTROLS

The electronic display panel consists of an LCD display with blue backlighting. When the power is first turned on, the display, with backlighting, will activate. If no buttons have been pressed and the fridge door is closed the backlighting will turn off after 30 seconds.

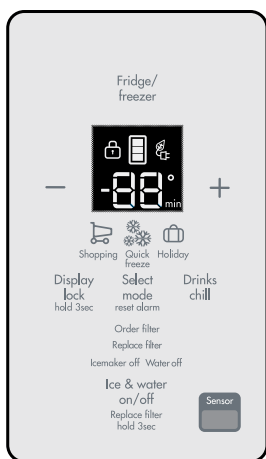

Controlling the temperature

We recommend that when you start your refrigerator for the first time, the temperature for the refrigerator is set to 3°C and the freezer to -18°C. If you want to change the temperature, follow the instructions below. Make only small adjustments and wait 24 hours to see if it's correct. Checking the softness of ice cream is a good indication if your freezer is the right temperature, while feeling the coldness of water kept in the refrigerator is a good way of checking the temperature of the food compartment.

NOTE: When you set a temperature, you set an average temperature for the whole refrigerator cabinet. Temperatures inside each compartment may vary, depending on how much food you store and where you place it. High or low room temperature may also affect the actual temperature inside the refrigerator.

If no button has been pressed for some time there may be a delay of up to 2 seconds before the display responds, this is normal and is a part of the display design to reduce the chance of accidental changes.

Changing the freezer temperature

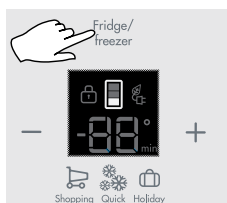

Press the Fridge/freezer button until the freezer compartment is illuminated on the refrigerator icon. Use the '-' and '+' buttons to the left and right of the display to select a lower or higher temperature in 1°C steps. Once the maximum of -23°C is reached, the display will return to -14°C with the next press of the button.

Changing the refrigerator temperature

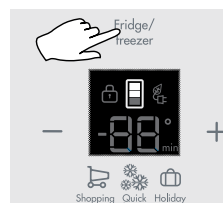

Press the Fridge/freezer button until the food compartment is illuminated on the refrigerator icon. Use the '-' and '+' buttons to the left and right of the display to select a lower or higher temperature in 1°C steps. Once 0°C is reached, the display will return to 7°C with the next press of the button.

Quick freeze function

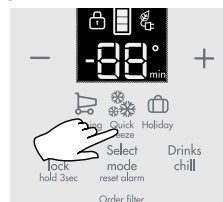

Use the quick freeze function when you add a large amount of food to the fridge compartment. To use this function, press the Modes button until Quick freeze is illuminated. Quick freeze function chills the food quickly but does not affect the temperature in the freezer compartment. The quick freeze function will operate for 90 minutes before automatically returning to normal operation. If you want to turn the quick freeze off before 90 minutes have passed, simply press the Modes button again until the Quick freeze icon disappears and the refrigerator will return to normal operation.

Freezer temperature alarm

If the alarm sounds for no apparent reason, check whether anything is keeping the door open. If the freezer becomes too warm due to the freezer door being left open or warm food being placed too close to the temperature sensor, a buzzer will sound.

If the freezer temperature alarm sounds, press any button to disable the alarm.

Make sure nothing is holding the freezer door open and move any warm food away from the temperature sensor. If the freezer is still too warm after 50 minutes, the alarm will sound again, indicating that something may be wrong with the refrigerator.

NOTE: The freezer temperature alarm can be reset for 12 hours by holding the alarm reset button continuously for 10 seconds.

USING YOUR ELECTRONIC CONTROLS

Door alarm

If the fridge or freezer door is left open for more than two minutes, the alarm will buzz and the refrigerator icon in the centre of the display will flash indicating which door is open. If you want to leave the door open while you load the refrigerator, you can turn the alarm off for 8 minutes by pressing any button, note that the icon will continue to flash until the door is closed.

If the fridge door is left open for more than 30 minutes, the light will automatically turn off to save energy. To turn the light back on simply close and reopen the door again.

Display lock

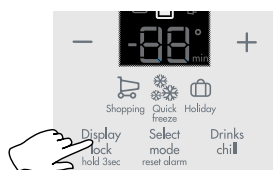

Press and hold the Display Lock button for 3 seconds to activate the display lock. This will disable the display to prevent accidental changes to settings. To turn the display lock off, hold the Display Lock button for 3 seconds.

Drinks chill timer

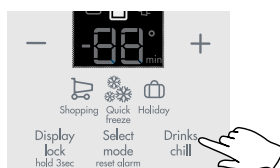

The drinks chill timer is used to quickly chill a bottle. Place the bottle in the freezer and the timer can be set for a minimum of 5 minutes to a maximum of 30 minutes. To set, simply press the drinks chill button and an initial time of 20 minutes appears. To adjust the timer use the '-' and '+' buttons to the left and right of the display to a maximum of 30 minutes or a minimum of 5 minutes in 5 minute steps. Once set, a time will count down one minute at a time.

You can change the time or turn the timer off even after the countdown has started. A buzzer will tell you when the time is finished and the icon will flash until the alarm reset button is pressed.

If your drink is not cold enough, reset the drinks chill function (remembering the drink is already partially chilled).

Suggested chilling times:

- 10 minutes for cans of drink.
- 20 minutes for bottles of wine.
- 30 minutes for bottles of soft drink.

Energy efficiency

Your refrigerator has been designed to be energy-efficient and can operate in three modes: Normal, Eco and Holiday.

• Eco mode

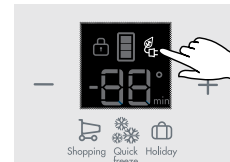

Eco mode is the default mode of your refrigerator. The leaf icon will automatically appear on the electronic display when your refrigerator is operating in Eco mode.

• Normal mode

Normal mode is used when you require extra cooling or when the refrigerator door is opened more than usual. The leaf symbol will disappear from the electronic display when your refrigerator is operating in normal mode.

Normal mode is activated when:

- The freezer compartment temperature setting is colder than -18°C
- The fresh food compartment temperature setting is colder than +3°C
- The quick freeze function is activated
- The door alarm is activated
- The freezer temperature alarm is activated.

• Holiday mode

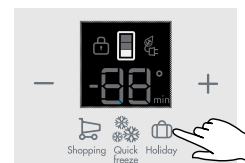

Use this function when you go on holiday or leave the house for long periods. The refrigerator minimises defrosting to save energy but maintains your temperature settings. To put the refrigerator into holiday mode, press the modes button until suitcase symbol is illuminated. The holiday mode will operate until the button is pressed again or the refrigerator door is opened.

NOTE: Opening the freezer drawer won't effect the operation of either Eco or Holiday modes.

USING YOUR ELECTRONIC CONTROLS

Sabbath mode



Entering Sabbath mode will disable all the refrigerator lighting, turn off the ice maker, water dispenser and prevent any other electrical activity from occurring as a result of the refrigerator doors being opened.

To enter Sabbath Mode press and hold the 'Display lock' and '-' buttons simultaneously for 3 seconds.

Four beeps will sound and the display will show 'sb' to indicate Sabbath Mode.

All alarm functions are disabled except for the High Temperature Alarm for reasons of food safety. If there is a high temperature issue during this period the alarm will sound intermittently for 10 minutes then turn off on its own.

To exit Sabbath Mode press and hold the 'Display Lock' and '-' buttons simultaneously for 3 seconds. Four beeps will sound and the refrigerator will resume normal operation.

Quick freeze

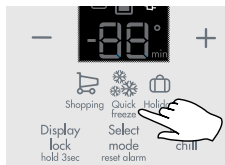

The Quick freeze mode allows for increased production of ice, which is useful for entertaining. To use this function, press the Modes button until Quick freeze is illuminated. The Quick freeze function will now operate for 12 hours. If you want to turn the Quick freeze off before 12 hours have passed, simply press the Modes button again until the Quick freeze icon disappears and the refrigerator will return to normal operation.

Disabling and enabling ice maker and water dispenser



To disable the automatic ice maker, press the Ice & Water On/Off button until the Icemaker off icon is illuminated. Press the button once more to disable the water dispenser, a water off icon will now be displayed. To disable both ice and water dispensers, press the button until both Icemaker off and Water off icons are displayed. Press the button once more to enable both ice and water dispensers.

Filter replacement



Your refrigerator is fitted with a water filter which periodically requires replacement. When your filter requires replacement, Order filter and Replace filter icons will appear as a reminder to both order and replace the water filter. When the replace filter icon appears an alarm will sound, pressing any button on the user interface will mute this alarm for one week.

When the filter has been replaced press and hold the 'Ice and Water' button for three seconds to reset the filter replace timer.

Other special refrigerator features

- Independent control of the compressor and fan to provide the best performance.
- Extra cooling depending on the number of times the door is opened.
- Automatically adjusts defrost time when the door is not frequently opened.

NOTE: Display malfunctions may be due to brief power supply interruptions. If this occurs, turn the refrigerator off at the power point and wait 5 minutes. The refrigerator pressure will need time to equalise before you turn the refrigerator on again. Changing the light bulb

USING YOUR REFRIGERATOR

This section tells you how to make the most of the many useful features - cleaning instructions can be found on page 18.

SpillSafe™ glass shelves

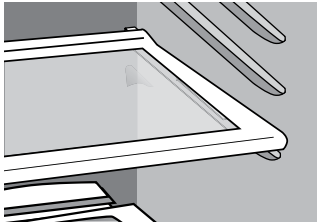

Spillsafe™ glass shelves keep spills on the shelf. A shelf retaining system minimises accidental movement of shelves and they can be adjusted to various heights. Spillsafe™ glass shelves are not to be used as slide out shelves. To remove the shelves, gently pull them forward until the shelf comes out.

Wine rack

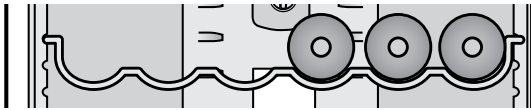

The wine rack can be used to store various types of bottles like wine or beer. Bottles should be stored with the bottom end towards the back of the refrigerator.

Door storage bins

The door storage bins adjust to meet different storage needs. All the door bins are completely removable for cleaning. If you want to remove or adjust a bin, lift it over the support lugs on the inner door panel. To replace, push the bin down over the support lugs to lock it in place.

Dairy compartment

Use the dairy compartment to store foods like butter, margarine and cheeses. The compartment is slightly warmer than the rest of the refrigerator compartment, while the lid provides protection against odours.

Crisper bin

Use the crisper bin to store vegetables, fruit or smallgoods. Change the humidity by sliding the humidity control.

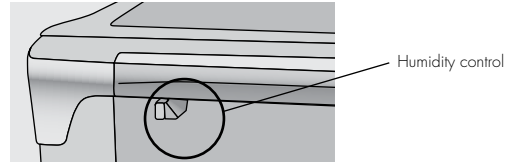

Storing vegetables

Store vegetables in the crisper bin and remember to set the humidity control to more humid (closed).

Storing fruit & smallgoods

Store fruit and smallgoods in the crisper bin and remember to set the humidity control to less humid (open).

Removal

1. Remove the crisper bin(s) by pulling forward, then up and forward again, lifting the bin off the slides. Push the extension slides back into the refrigerator.

To refit

1. Slide the bin into place over the telescopic slides
2. Push the bin in until it stops, noting that the bin will not be closed all the way.
3. Open the bin to access the finger tabs at the ends on each side of the bin. Use your thumb and forefinger to lift the bin over the end of the slide and clip in place.
4. Fully close the bin.

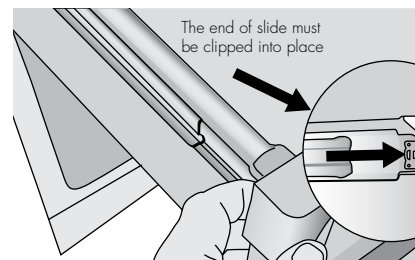

USING YOUR REFRIGERATOR

Freezer bin

The bins are mounted on telescopic extension slides, to enable full access to the contents. A clear plastic front provides easy visibility of the contents.

Removal

1. Empty food from the bin.
2. Remove the bin by pulling forward and lifting the front to unhook from the slides. Once you have removed the bins, ensure the slides are pushed back so they are fully closed.

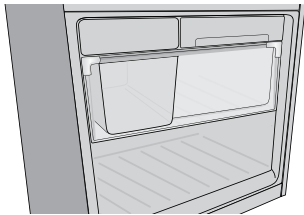

To refit

1. With the runners pushed in all the way.
2. Slide the bin into place over the telescopic slides and under the shelf. Push the bin in until it stops, noting that the bin will not be closed all the way.
3. Open the bin to access the finger tabs at the ends on each side of the bin. Use your thumb and forefinger to lift the bin over the end of the slide and clip in place.
4. Fully close the bin.

Freezer bottom bin

To remove the bin, pull the drawer out until it is open all the way then lift bin out from the front of the bin. When refitting insert the rear of the bin first then lower into position.

When replacing the bins after cleaning, we recommend fitting the lower bin first.

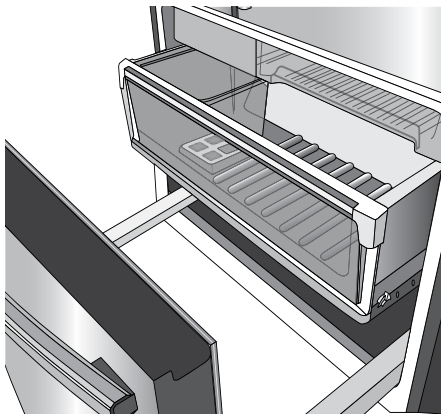

CAUTION

Never store solvents or flammable materials like nail polish remover or lighter fluid inside your refrigerator. They will affect the life of the plastic components and may taint stored food.

CAUTION

Never close the door while the telescopic slides are extended. It may damage the slide and/or the refrigerator or cause the slide to become disengaged from the refrigerator.

CAUTION

To clean a crisper or freezer bin with telescopic extension slides, simply wipe with a damp cloth and warm soapy water. Never immerse the cover in water, as this could affect the operation of the slide.

CARE AND MAINTENANCE

LED lighting



CAUTION

Your refrigerator is fitted with long life LED lighting. In the unlikely event the LED lights should fail, then the LED lights should be serviced by the manufacturer, it's service agent or similarly qualified technician. Refer to the warranty page for contact details.

When the door is left open for 15 minutes, the LED light will dim to 50% brightness to conserve energy and prolong the life of the LED. If the door is left open for a further 15 minutes, the light will automatically turn off. Close and reopen the door again to turn the light back on.

Deodoriser

Your appliance is fitted with a deodoriser to assist with the removal of food odours inside your appliance. Odours are removed by absorption through the filter by the normal operation of the appliance. Keeping food covered and wrapping food with plastic wrap will also help to reduce the odours inside your appliance.

Cleaning the appliance



WARNING

Before cleaning: Turn appliance off at the power point, then remove power cord from socket. This will make sure there is no chance of getting an electric shock.

- Doors – stainless steel
This stainless steel has a special advanced protective coating that eases the removal of marks such as finger prints and water spots. To keep your stainless steel appliance looking at its best, you should clean it regularly. You should only clean the stainless steel doors with luke-warm soapy water and a soft cloth, rinsing with clean water and then wipe the surface with clean water and a soft clean cloth to remove soap residue.
- Doors - cabinet & painted doors
An occasional wipe over with a clean, damp cloth will help remove finger marks. You should only clean the doors with lukewarm, soapy water and a soft cloth. Rinse with clean water and then wipe the surface with a soft, clean cloth to remove any soapy residue.

NOTE: Only wash plastic parts or decorative trim with warm (not hot) water using an unscented detergent.



CAUTION

Do not use stainless steel cleaners, abrasive pads or other cleaners as they are likely to scratch the surface. Damage to this product after delivery is not covered by your warranty.

- Interior
You should clean the appliance interior regularly. It will be easiest to clean when the food supply is low. Wash the interior with a soft cloth and use an unscented mild soap with lukewarm water. Thoroughly dry all surfaces and removable parts. Avoid getting water on appliance controls. If you have taken out any removable parts, replace them and switch the power on before re-stocking the appliance with food. Naturally, you should keep the interior of your appliance hygienic by promptly and thoroughly wiping up any food spills.
Do not use a steam cleaner. If live components come into contact with condensing steam, they may short-circuit or cause an electric shock.
- Door seals
Take care to keep door seals clean. Sticky food and drink can cause seals to stick to the cabinet and tear when you open the door. Wash seal with a mild detergent and warm water. Rinse thoroughly and dry.



CAUTION

Never use hot water, solvents, commercial kitchen cleaners, aerosol cleaners, metal polishes, caustic or abrasive cleaners, or scourers to clean this appliance, as they will damage it. Many commercially available cleaning products and detergents contain solvents that will damage your refrigerator. When cleaning, use only a soft cloth with an unscented mild soap and lukewarm water.

TROUBLESHOOTING

If you think something may be wrong with your refrigerator, you can carry out some easy checks before calling for service. You may locate the problem, sparing yourself from inconvenience, saving time and money.

problem	solution
Refrigerator is not operating	<ul style="list-style-type: none"> • Check that the power cord is plugged into the power outlet properly and that the outlet is switched 'ON'. • Try running another appliance from the power outlet. If no power is coming from the outlet you may have blown a fuse or tripped a circuit of your household power supply. • Try adjusting the temperature control to a slightly "colder" position. • It is normal for the freezer fan NOT to operate during the automatic defrost cycle, or for a short time after the appliance is switched on.
When there is refrigerator/freezer noise	<p>Modern refrigerators/freezers with increased storage capacity use high speed compressors. These can provide a seemingly high level of sound which is quite normal. Normal operational sounds include:</p> <ul style="list-style-type: none"> • Occasional gurgling, similar to water boiling. • Air flow noise (air circulates because of a small fan). • A popping noise heard during automatic defrost. • A clicking noise heard just before the compressor starts (this is just the automatic switching action of the temperature control, turning the compressor on or off). <p>Other strange sounds may mean that you need to check and take action. For example, noises may mean that:</p> <ul style="list-style-type: none"> • The cabinet is not level. • The floor is uneven or weak. • Bottles are badly placed and rattling. • There are vibrations from an object on top of or behind or beside the refrigerator. • The back of the refrigerator cabinet is touching the wall. <p>Remember it is quite normal for noise to seem louder just after the refrigerator starts operating.</p>
If there are odours inside the refrigerator	<ul style="list-style-type: none"> • The interior may need cleaning. • Some foods produce odours. • Some containers and wrapping can cause odours. • Ask yourself if the odour started about the same time you started storing something unusual.
When the motor seems to run more than expected	<p>Your new refrigerator has a large fridge and freezer section to keep cool. So it is normal to frequently hear the sound of the motor. However, to keep operation to a minimum check the following:</p> <ul style="list-style-type: none"> • Are doors kept open too long or too often? • Are controls set too cold? See 'Controlling the temperature' on pages 11. • Have large amounts of warm food just recently been stored? Summer, festive seasons and holidays usually mean a lot more work for your refrigerator. • If the day is hot or the room is very warm, the refrigerator will need to run more than normal. • The refrigerator will run more than normal just after you install it or when it has been turned off for a long time.
If the temperature in the refrigerator is too warm	<ul style="list-style-type: none"> • Check that the appliance has enough clearance at the sides, back and top. Refer to the installation instructions on page 7. • Refer to 'Controlling the temperature' on pages 11. • You may have kept the door open too long or too frequently. • Food containers or packaging may be holding a door open.
If the temperature in the refrigerator is too cold	<ul style="list-style-type: none"> • Refer to 'Controlling the temperature' on page 11. • Increase the temperature to avoid high energy consumption.
If heavy frosting occurs in the freezer	<p>Make sure you fully close the freezer and fridge doors. If the doors are left open, a heavy frost will coat the inside of the freezer. If a frost develops, remove it and take care to properly close the doors.</p>
If water drips on the floor	<p>The defrost water tray, (located at the back or underneath of the cabinet) may not be properly positioned, or the drain tube may not be properly positioned to direct water into this tray. You may need to pull the refrigerator away from the wall to check the tray and tube.</p>
Fridge does not exit holiday mode	<p>Turn appliance off at the power point. Leave off for three (3) minutes for the memory to clear, then turn back on.</p>
If the doors will not close	<ul style="list-style-type: none"> • Check whether the top of the refrigerator is tilted back 10-15mm to allow the doors to self close. • Check whether something is holding the door open. <p>It is normal for the french doors to momentarily open and re-close when the food storage compartment door is closed. If the french doors stay open, the refrigerator needs to be tilted backwards a little further. If you call a service person to solve this problem you will be charged for the cost of the service call, this is not a warranty fault.</p> <p>Check bins are positioned correctly on slides after cleaning.</p>

ICE + WATER TROUBLESHOOTING

problem	solution
Automatic ice-maker	
The ice maker is not making any ice	<ul style="list-style-type: none"> • See Ice maker section in user manual: turn icemaker on. • Turn on the water tap. • See the Problem section: 'If the temperature in the refrigerator is too warm'. • The ice & water filter cartridge may be clogged or restricted by foreign material, and will need to be replaced. • Check and/or change filter.
The ice-maker is not making enough ice	<ul style="list-style-type: none"> • The ice maker should produce approximately 0.5-1 kilogram of ice every 24 hours. • Open the household water tap. • Replace the water filter cartridge. • See section 'Controlling temperatures'.
Ice cubes are too small or too big	<ul style="list-style-type: none"> • Replace the filter cartridge, as the water filter cartridge may be clogged. • Check water supply hose for kinks. • Check water pressure meets minimum and maximum requirement (see install instructions).
The ice has a bad odour and taste	<ul style="list-style-type: none"> • Cover foods tightly. Discard stale ice. The ice maker will produce a fresh supply. • Add or replace water filter to water supply. Consult a water purifying company. • Discard stale ice monthly.

IF YOU STILL REQUIRE SERVICE

If you have a problem, and the problem persists after you have made the checks mentioned, contact your nearest Electrolux approved Service Centre or the dealer you bought the refrigerator from. Be ready to quote the model number, 9-digit PNC and 8-digit serial number, which is stated on the label inside the refrigerator compartment.

This document sets out the terms and conditions of the product warranties for Electrolux Appliances. It is an important document. Please keep it with your proof of purchase documents in a safe place for future reference should you require service for your Appliance.

1. In this warranty:
 - (a) 'acceptable quality' as referred to in clause 10 of this warranty has the same meaning referred to in the ACL;
 - (b) 'ACL' means Schedule 2 to the Competition and Consumer Act 2010;
 - (c) 'Appliance' means any Electrolux product purchased by you and accompanied by this document;
 - (d) 'ASC' means Electrolux authorised service centres;
 - (e) 'Electrolux' means Electrolux Home Products Pty Ltd of 163 O'Riordan Street, Mascot NSW 2020, ABN 51 004 762 341 in respect of Appliances purchased in Australia and Electrolux (NZ) Limited (collectively 'Electrolux') of 3-5 Niall Burgess Road, Mount Wellington, in respect of Appliances purchased in New Zealand;
 - (f) 'major failure' as referred to in clause 10 of this warranty has the same meaning referred to in the ACL and includes a situation when an Appliance cannot be repaired or it is uneconomic for Electrolux, at its discretion, to repair an Appliance during the Warranty Period;
 - (g) 'Warranty Period' means the Appliance is warranted against manufacturing defects in Australia and New Zealand for 24 months and for the Appliance's compressor, condenser, evaporator and drier, an additional 36 months parts only warranty applies, following the date of original purchase of the Appliance;
 - (h) 'you' means the purchaser of the Appliance not having purchased the Appliance for re-sale, and 'your' has a corresponding meaning.
2. This warranty only applies to Appliances purchased and used in Australia or New Zealand and used in normal domestic applications and is in addition to (and does not exclude, restrict, or modify in any way) any non-excludable statutory warranties in Australia or New Zealand.
3. During the Warranty Period Electrolux or its ASC will, at no extra charge if your Appliance is readily accessible for service, without special equipment and subject to these terms and conditions, repair or replace any parts which it considers to be defective. Electrolux or its ASC may use remanufactured parts to repair your Appliance. You agree that any replaced Appliances or parts become the property of Electrolux. This warranty does not apply to light globes, batteries, filters or similar perishable parts.
4. Parts and Appliances not supplied by Electrolux are not covered by this warranty.
5. To the extent permitted by law, you will bear the cost of transportation, travel and delivery of the Appliance to and from Electrolux or its ASC. If you reside outside of the service area, you will bear the cost of:
 - (a) travel of an authorised representative;
 - (b) transportation and delivery of the Appliance to and from Electrolux or its ASC.

In all instances, unless the Appliance is transported by Electrolux or an Electrolux authorised representative, the Appliance is transported at the owner's cost and risk while in transit to and from Electrolux or its ASC.
6. Proof of purchase is required before you can make a claim under this warranty.
7. You may not make a claim under this warranty unless the defect claimed is due to faulty or defective parts or workmanship. Electrolux is not liable in the following situations (which are not exhaustive):
 - (a) the Appliance is damaged by:
 - (i) accident
 - (ii) misuse or abuse, including failure to properly maintain or service
 - (iii) normal wear and tear
 - (iv) power surges, electrical storm damage or incorrect power supply
 - (v) incomplete or improper installation
 - (vi) incorrect, improper or inappropriate operation
 - (vii) insect or vermin infestation
 - (viii) failure to comply with any additional instructions supplied with the Appliance;
 - (b) the Appliance is modified without authority from Electrolux in writing;
 - (c) the Appliance's serial number or warranty seal has been removed or defaced;
 - (d) the Appliance was serviced or repaired by anyone other than Electrolux, an authorised repairer or ASC.
8. This warranty, the contract to which it relates and the relationship between you and Electrolux are governed by the law applicable where the Appliance was purchased. Where the Appliance was purchased in New Zealand for commercial purposes the Consumer Guarantee Act does not apply.
9. To the extent permitted by law and subject to your non-excludable statutory rights and warranties, Electrolux excludes all warranties and liabilities (other than as contained in this document) including liability for any loss or damage whether direct or indirect arising from your purchase, use or non use of the Appliance.
10. For Appliances and services provided by Electrolux in Australia, the Appliances come with a guarantee by Electrolux that cannot be excluded under the ACL. You are entitled to a replacement or refund for a major failure and for compensation for any other reasonably foreseeable loss or damage. You are also entitled to have the Appliance repaired or replaced if the Appliance fails to be of acceptable quality and the failure does not amount to a major failure. The benefits to you given by this warranty are in addition to your other rights and remedies under a law in relation to the Appliances or services to which the warranty relates.
11. At all times during the Warranty Period, Electrolux shall, at its discretion, determine whether repair, replacement or refund will apply if an Appliance has a valid warranty claim applicable to it.
12. For Appliances and services provided by Electrolux in New Zealand, the Appliances come with a guarantee by Electrolux pursuant to the provisions of the Consumer Guarantees Act, the Sale of Goods Act and the Fair Trading Act.
13. To enquire about claiming under this warranty, please follow these steps:
 - (a) carefully check the operating instructions, user manual and the terms of this warranty;
 - (b) have the model and serial number of the Appliance available;
 - (c) have the proof of purchase (e.g. an invoice) available;
 - (d) telephone the numbers shown below.
14. You accept that if you make a warranty claim, Electrolux and its ASC may exchange information in relation to you to enable Electrolux to meet its obligations under this warranty.

Important Notice

Before calling for service, please ensure that the steps listed in clause 13 above have been followed.

<p>FOR SERVICE or to find the address of your nearest state service centre in Australia PLEASE CALL 13 13 49 For the cost of a local call (Australia only)</p>	<p>SERVICE AUSTRALIA  Electrolux ELECTROLUX HOME PRODUCTS www.electrolux.com.au</p>	<p>FOR SPARE PARTS or to find the address of your nearest state spare parts centre in Australia PLEASE CALL 13 13 50 For the cost of a local call (Australia only)</p>
<p>FOR SERVICE or to find the address of your nearest authorised service centre in New Zealand FREE CALL 0800 10 66 10 (New Zealand only)</p>	<p>SERVICE NEW ZEALAND  Electrolux ELECTROLUX (NZ) Limited www.electrolux.co.nz</p>	<p>FOR SPARE PARTS or to find the address of your nearest state spare parts centre in New Zealand FREE CALL 0800 10 66 20 (New Zealand only)</p>

**For more information on all Westinghouse appliances,
or for dimension and installation information, call into your retailer,
phone or email our customer care team or visit our website:**

AUSTRALIA

phone: 1300 363 640
fax: 1800 350 067
email: customercare@electrolux.com.au
web: www.westinghouse.com.au

NEW ZEALAND

phone: 09 573 2384
fax: 0800 363 600
email: customercare@electrolux.co.nz
web: www.westinghouse.co.nz

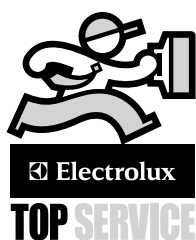

TOP SERVICE

Top Service encompasses the after sales service provided by The Electrolux Group to consumers including delivery, home service and spare parts.

**Westinghouse. We are part of the Electrolux family.
Share more of our thinking at www.electrolux.com**

© 2014 Electrolux Home Products Pty Ltd ABN 51 004 762 341
WMAN_FDFRI_IW_Mar14

Part number: A00394501

