

USER MANUAL

Large French Door Refrigerator

WHE7670SA



Westinghouse

made for modern families

CONGRATULATIONS

Dear customer,
 Congratulations and thank you for choosing our refrigerator. We are sure you will find your new appliance a pleasure to use. Before you use the appliance, we recommend that you read through the entire user manual, which provides the description of the appliance and its functions. To avoid the risks that are always present when you use an electrical appliance, it is important that the appliance is installed correctly and that you read the safety instructions carefully to avoid misuse and hazards. We recommend that you keep this instruction booklet for future reference and pass it on to any future owners. After unpacking the appliance, please check that it is not damaged. If in doubt, do not use the appliance but contact your local customer care centre.

CONDITIONS OF USE

This appliance is intended to be used in household and similar applications such as:

- staff kitchen areas in shops, offices and other working environments
- farm houses
- by clients in hotels, motels and other residential type environments
- bed and breakfast type environments

TIPS & INFORMATION

IMPORTANT – CHECK FOR ANY DAMAGES OR MARKS

If you find the refrigerator is damaged or marked, you must report it within 7 days if you wish to claim for damage/marks under the manufacturer's warranty. This does not affect your statutory rights.

BEFORE YOU CALL

Please ensure you read the instruction manual fully before you call for service, or a full service fee could be applicable.

CONTENTS

General warnings	2
How to use interior parts	5
Installation guide	6
Control panel	6
Temperature control	7
How to use the dispenser	7
How to use the automatic icemaker	7
Care & cleaning	8
Ice & water installation	10
Before you call for service	9
Trouble shooting	10
If the refrigerator can not pass through a door during installation, follow these steps	10
Installation preparation	11
Refrigerator leveling & door adjustment (if needed)	13
How to install water line	13
Warranty	15

GENERAL WARNINGS

Please read the user manual carefully and store in a handy place for later reference. Pass the user manual on to new owners of the refrigerator.

The symbols you will see in this booklet have these meanings:

WARNING

This symbol indicates information concerning your personal safety

CAUTION

This symbol indicates information on how to avoid damaging the refrigerator

TIPS & INFORMATION

This symbol indicates tips and information about use of the refrigerator

ENVIRONMENTAL TIPS

This symbol indicates tips and information about economical and ecological use of the refrigerator

CAUTION

1. If the supply cord becomes damaged, it must be replaced by the manufacturer or its service agent or a similarly qualified person in order to avoid a hazard.
2. This appliance is not intended for use by persons (including children) with reduced physical, sensory or mental capabilities, or lack of experience and knowledge, unless they have been given supervision or instruction concerning use of the appliance by a person responsible for their safety.

DISPOSAL OF USED ELECTRICAL & ELECTRONIC EQUIPMENT

The meaning of the symbol on the product, its accessory or packaging indicates that this product shall not be treated as household waste. Please, dispose of this equipment at your applicable collection point for the recycling of electrical & electronic equipments waste. By ensuring the correct disposal of this product, you will help prevent potential hazards to the environment and to human health, which could otherwise be caused by unsuitable waste handling of this product. The recycling of materials will help conserve natural resources. Please do not therefore dispose of your old electrical and electronic equipment with your household waste. For more detailed information about recycling of this product, please contact your local city office or your household waste disposal service.

WARNING

- When you dispose of your old refrigerators and freezers, remove any doors. Children can suffocate if they get trapped inside.
- This appliance is not intended for use by persons (including children) with reduced physical, sensory or mental capabilities, or lack of experience and knowledge, unless they have been given supervision or instruction concerning use of the appliance by a person responsible for their safety. Children should be supervised to ensure that they do not play with the appliance.
- Don't use a steam cleaner. If live components come into contact with condensing steam, they may short-circuit or cause an electric shock.
- Do not use mechanical devices or other means to accelerate the defrosting process other than those recommended by the manufacturer.
- This appliance contains insulation formed with flammable blowing gases. Avoid safety hazards by carefully disposing of this appliance.

REFRIGERANT INFORMATION (R-134A MODELS ONLY)

Refrigerant	R-134a
Charge	0.190kg
Global Warming Potential	1300
Contains fluorinated greenhouse gases covered by the Kyoto Protocol and is hermetically sealed. Foam is blown with cyclo-pentane gas, a pure hydrocarbon.	

OBSERVE AMBIENT TEMPERATURE











This refrigerator is designed to operate in ambient temperature specified by its category, which is marked on the rating plate.

NOTE: Internal temperature may be affected by such factors as the location of the refrigerator, ambient temperature and frequency of the door opening.

Read the following carefully to avoid damage or injury

 **THIS SYMBOL INDICATES NEVER TO DO THIS**

 **THIS SYMBOL INDICATES ALWAYS DO THIS**

WARNING	
	Never let the power cord be crushed by the refrigerator itself or other (heavy) objects. Never bend power cord excessively. <ul style="list-style-type: none"> • If the cord is damaged or peeled, it can be a cause of fire and electric shock.
	Do not plug several appliances into the same wall outlet. <ul style="list-style-type: none"> • It can be a cause of overheating and/or fire. Use an exclusive grounding receptacle for the refrigerator.
	Never hold the power cord or plug with wet hands. <ul style="list-style-type: none"> • There is a risk of electric shock.
	Never use a damaged power cord or plug, or loose main socket. <ul style="list-style-type: none"> • There is a risk of fire, electric shock or serious injury.
	Be sure to ground. Check if your wall outlet is grounded (earthed). <ul style="list-style-type: none"> • There is a risk of electric shock hazards.
	Never unplug by pulling only the power cord wire. Always grip the plug firmly.
	Let the cord from the plug outlet be directed downwards. <ul style="list-style-type: none"> • If it is directed up, the cord near the plug is bent and can be damaged, which can cause an electric shock or fire.
	Do not install the refrigerator on a wet floor or in a place with excessive humidity and moisture. <ul style="list-style-type: none"> • Electric insulation gets weakened, resulting in a risk of electric shock hazards.
	Never let the power cord touch or pass over heating appliances. <ul style="list-style-type: none"> • Power cord can be damaged, resulting in a risk of electric shock hazards.
	Check if plug is loose from the wall outlet. <ul style="list-style-type: none"> • Electric insulation gets weakened, resulting in a risk of electric shock hazards.
	Never pour or spray water into the refrigerator (both interior and exterior). <ul style="list-style-type: none"> • Electric insulation gets weakened, resulting in a risk of electric shock hazards.

- ⊘ Do not place containers with water or liquid on top of refrigerator.
 - Water can spill into the refrigerator and can cause electric shock hazards or damage.
- ⊘ Do not let children hang on the refrigerator doors.
 - Refrigerator can fall and harm them.
- ⊘ Do not move or remove compartment shelves/pockets while foods and containers are on them.
 - Hard containers (of glass, metal etc.) can fall to hurt you and can break glass shelf and interior parts.
- ⊘ Never repair, disassemble or amend the refrigerator on your own.
 - There is a risk of personal injury or damage to the refrigerator. It is recommended that any service be carried out by a qualified person.
- ⊘ Never use flammable gas, benzene, thinners, gasoline, spray etc. near the refrigerator.
 - There is a risk of fire, explosion and personal injury or damage.
- ⊘ If a gas leak is found near the refrigerator or in the kitchen, ventilate it immediately without touching the power plug or refrigerator.
- ⊘ Do not store medicine, academic research samples which require strict temperature control in the refrigerator.
- ⊘ Never insert fingers or hands into the bottom of the refrigerator, especially into the bottom back.
 - You can be hurt by sharp metal edges or can receive an electric shock.
- ⊘ Do not change fuse or LED lamp on your own. Call the service agent to change them.
- ⊘ When you find the power cord damaged or cut, call the service agent immediately.
- ⊘ When you get rid of your old refrigerator, be sure to remove the door packings first.
 - Children can be entrapped and suffocated in an abandoned refrigerator.

- CAUTION**
- ⊘ Be sure to unplug the refrigerator when it is not going to be used for a long time.
 - ⊘ Never touch foods and containers especially of metal with wet hands in the freezer compartment.
 - You can be hurt by chilblains or cold burns.
 - ⊘ Never eat any decayed or deteriorated food at all.
 - Foods stored too long in the refrigerator can deteriorate and become decayed.
 - ⊘ Never place bottles and containers of glass in the freezer compartment.
 - Glass containers and bottles can break and hurt you.
 - ⊘ When moving the refrigerator (horizontally or tilted), more than 2 persons are required to hold it. (One to hold top back handles, the other to hold the bottom holder.) If other parts are held instead, it is very dangerous and likely to slip.
 - ⊘ Be sure to turn up the wheel first before moving the refrigerator.
 - The wheels can damage or scratch the floor. If you are moving it for a long distance, never forget to fasten the interior parts tightly with tapes.
 - Otherwise, the parts can collide and break each other.

HOW TO USE THE INTERIOR PARTS



- | | |
|--|--|
| 1 Door storage compartment for storing butter and cheese | 7 Adjustable glass shelf for storing common food |
| 2 Door storage compartment for storing refrigerated food of small size | 8 Small glass shelf for storing common food |
| 3 Door storage compartment for storing refrigerating food | 9 Vegetable case |
| 4 Door storage compartment for storing refrigerated food | 10 Wide case |
| 5 Ice maker/Ice storage bin for making and storing ice | 11 Freezer case |
| 6 Water filter | 12 Freezer drawer |
| | 13 Control and display panel |
| | 14 Egg case |
| | 15 Ice storage case |

Features may vary depending on model. Not all models will have features listed.

INSTALLATION GUIDE

Read these safety instructions carefully before use and follow precautions for your safety.



WARNING

PRECAUTIONS IN INSTALLATION AND POWER CONNECTION

To prevent fire, electric shock or leakage

– Never install the refrigerator on a wet, watery floor or where water can gather easily.

– Check the following before power connection.

- Connect power plug only to a grounded wall socket (an earthed mains).
- Do not plug refrigerator power together with other appliances to the same socket.
- Do not use an adapter plug or an extension cord.
- Do not let the power cord be crushed by other (heavy) objects.
- If you hear a strange noise, strong chemical odour or find smoke etc. from the refrigerator after the power is plugged in, pull out the plug immediately and call the service agent.
- Wait about 5 minutes before you plug-in again in order to prevent any damage to the compressor and electrical devices of refrigerator.
- Wait 2~3 hours until the inside gets cold enough after the first power plug-in, then store foods inside. (There can be some smell of plastic parts on initial operation of the refrigerator after plugging in. The smell fades away as the refrigerator works and doors are opened and closed.)



WARNING

PRECAUTIONS IN USE

To prevent personal injury, fire, electric shock etc. read this user guide carefully before use and keep it at hand for any reference.

ACCESSORIES

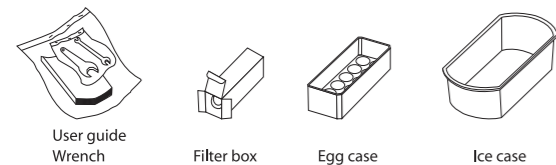

User guide
Wrench

Filter box

Egg case

Ice case

CONTROL PANEL

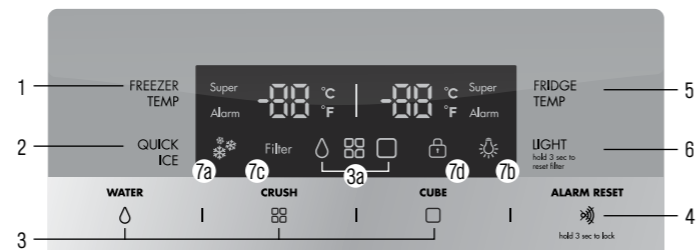

1. FREEZER TEMP button
Selection button for freezer compartment temperature.
2. QUICK ICE button
Quick ice cube production on/off switch
3. WATER/ICE dispenser button
For your convenience you can select WATER / CUBED ICE or CRUSHED ICE.

WATER **CRUSH** **CUBE**



3a. An icon is illuminated when your selection is activated:

Water

Crushed Ice

Cubed Ice

To obtain the water or ice, push the pad smoothly with your cup and your selection will come out 1 to 2 seconds later.

– Try to avoid placing the rim of your glass near the bottom of the pad, otherwise water or ice cubes may spill or splash.

4. ALARM RESET
Switching the warning signal off
Switching panel lock on/off
5. FRIDGE TEMP button
Selection button for refrigerator compartment temperature.
6. LIGHT/FILTER button
 - Button for dispenser light on.
 - Button for filter exchange or reset.
After exchanging or to reset, press the button for 3 seconds.
7. Symbols on the display panel
 - 7a. Quick ice – appears when the “quick ice” function is on.
 - 7b. Light – appears when the water dispenser light is on.
 - 7c. Water filter : Filter exchange display
The filter indicator will remain illuminated once the refrigerator has been turned on. After 6 months of first power input, the icon will flicker to advise that the filter needs to be changed. When the appliance is turned off, the water filter symbol is reset.
- 7d. Panel lock

TEMPERATURE CONTROL

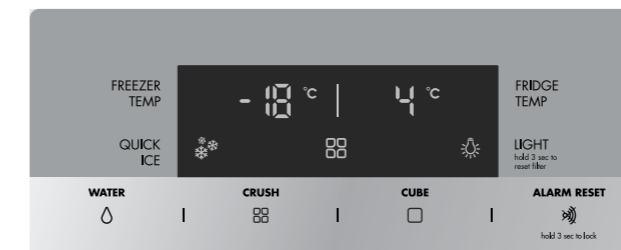

When this refrigerator is first plugged in, the temperature mode is set to [Middle].

FREEZER COMPARTMENT

Push the Freezer Temp button and the setting temperature changes as the figure shows.



When you want faster freezing, push the Freezer Temp button, until ‘Super’ LED turns on. Just push the button again to release.

REFRIGERATOR COMPARTMENT

Push the Fridge Temp button and the setting temperature changes as the figure shows.



When you want faster freezing, push the Fridge Temp button, until ‘Super’ LED turns on. Just push the button again to release.

*NOTE: Temperature indicator convert function (Fahrenheit – Celsius)
Press “Alarm Reset” button to enter locked mode. Under the locked mode, press and hold “quick ice” button for 15 seconds until the temperature unit switches.*



CAUTION

Food in the refrigerator can be frozen if the ambient temperature of the refrigerator is below 5°C.

HOW TO USE THE DISPENSER

Press either the ‘(WATER)’, ‘(CRUSHED ICE)’ or ‘(ICE CUBE)’ button, and smoothly push the lever with your cup.



CAUTION

- Avoid using thin fragile cups or crystal glasses when taking ice cubes.
- For your safety, never insert your fingers or other tools into the dispenser outlet.
- If you find the ices discoloured, stop using the dispenser and call the service agent.

HOW TO USE THE AUTOMATIC ICEMAKER (dispenser models only)

- The ice maker can make approx, 100 ice cubes within 24 hours. If the ice storage case is full, ice making stops.
- The first button press will activate the electronic panel and the second button press will comence dispensing ice or water. The button needs to be held down to continue dispensing.
- It is normal for the icemaker to make banging sounds when the ice cubes are falling into the ice storage case.
- To prevent bad odour or smell, regularly clean the ice cube’s storage case.
- The water may continue to run for 2 seconds after the water dispensing button is pressed.
- If the amount of ice in the storage case is not sufficient, the ice may not be dispensed. Wait a day or so to make more ice.
- If the ice does not dispense easily, ensure the dispenser outlet is not blocked.

IN CASE THE ICE MAKER DOESN'T WORK

If the ice cubes get stuck and not dispensed

- Pull out the ice storage case and separate any ice cubes that may have stuck together.
- If the amount of water which is supplied to the icemaker needs adjusting, call for the service agent.

IN CASE OF POWER FAILURE

- The ice cubes in the storage case may melt to flow down to the ice dispenser.
- If many hours of power failure is predicted, pull out the storage case, remove the ice cubes in it and replace it back when power resumes.

CARE & CLEANING

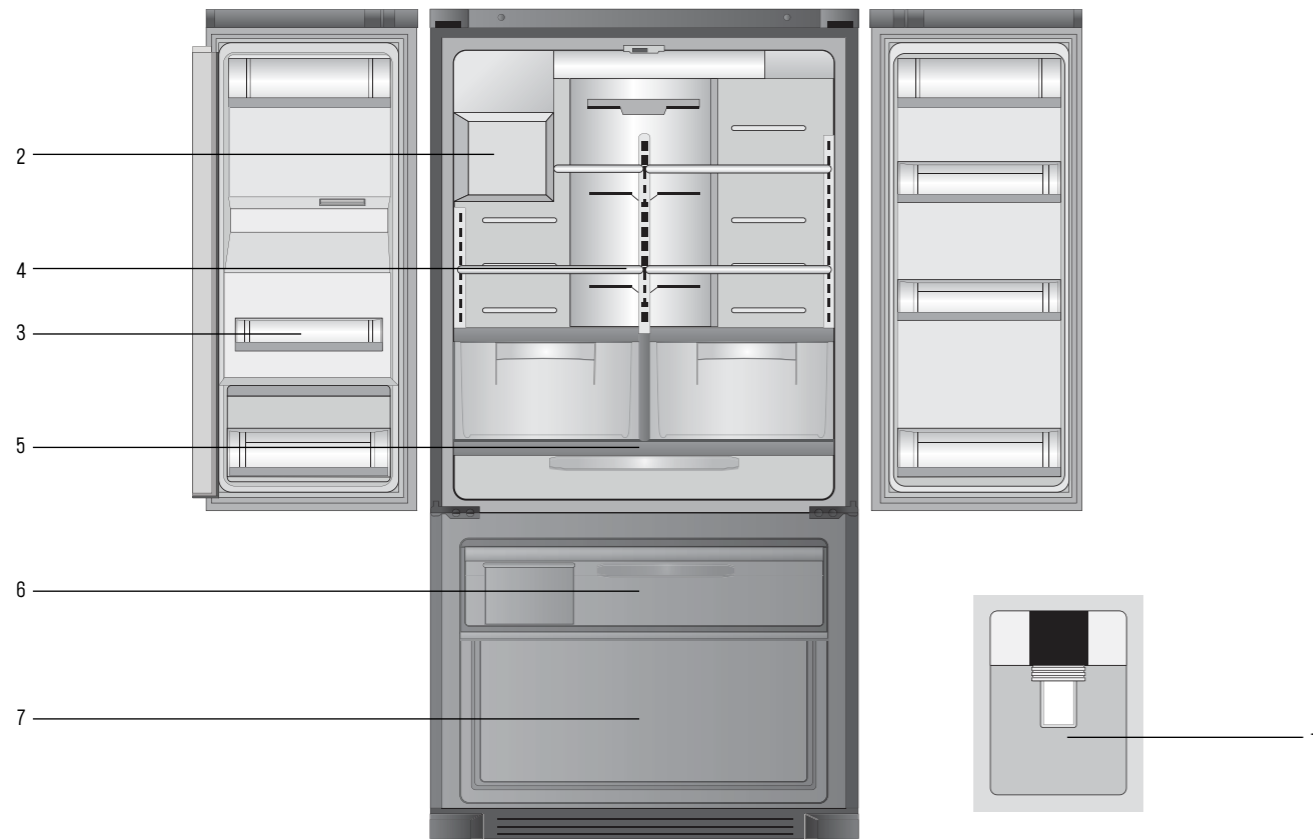

1. Water Dispenser

- Remove the strainer and clean the water collecting tray with a sponge or absorbent cloth.

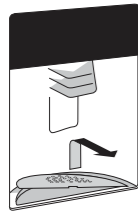

2. Ice Cubes Storage Case

- Removing: Press the release button and remove the ice cube container.
- Cleaning: Empty the ice cube container and clean with tepid water. Thoroughly dry the container and screw conveyor to prevent new ice cubes from sticking.
- Replacing: Push the ice cube container all the way back onto the supports until it locks into position. If the container cannot be pushed all the way back, rotate the swirl coil a quarter turn and insert again.

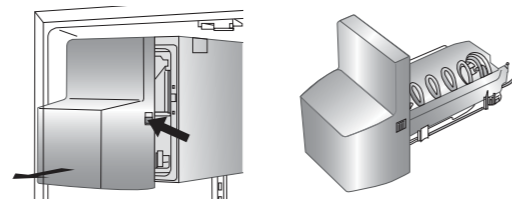

3. Freezer & Refrigerator Bins

- Hold both ends and pull up.

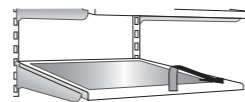

4. Refrigerator Shelves

- Lift up and pull the shelf, unhook and then remove the shelf. You can replace it at varying heights.
- To place taller items such as tall bottles, you can remove the small glass shelf and place it in the holder under the icemaker.



5. Vegetable Case & Wide Case

- Pull out the cases as far as possible. Lift up the front of the cases and pull them out.
- Insert the cases into the rail and push toward the back.

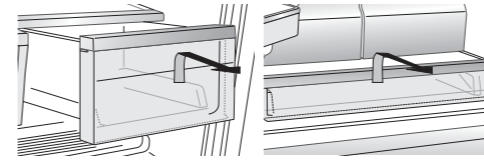

6. Freezer Case

- Pull out the case as far as possible. Pull out the clips on both sides and lift up the front of the freezer case.

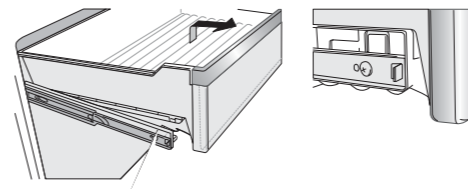

7. Freezer Drawer

- Lift the freezer drawer up and out.

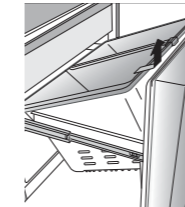

HOW TO CLEAN

Interior Parts

- Use cloth with water and mild (neutral) detergent to clean.



Back (Machine section)

- Remove dust on grill with a vacuum cleaner at least once a year.

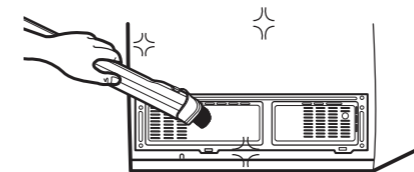

CAUTION

Never use gasoline (petrol), benzene (benzol), thinners etc, for they can damage the surfaces. Your warranty may be voided by an incorrect installation.

BEFORE YOU CALL FOR SERVICE

PROBLEM	SOLUTION
It never gets cold inside. Freezing & refrigerating is not so good.	<p>Checkup Point</p> <ol style="list-style-type: none"> Is the refrigerator unplugged? Is the temperature set to [Low Mode]? Is the refrigerator under direct sunlight or is a heat appliance placed near it? Is the space between the refrigerator back and the wall too close? <p>Action</p> <ol style="list-style-type: none"> Plug in the refrigerator. Set the temperature mode to Middle or High. Move to a place where there is no direct sunlight, no heat appliances around. Keep sufficient space (more than 5cm) between the back of the refrigerator and the wall.
Foods in the refrigerator get frozen.	<p>Checkup Point</p> <ol style="list-style-type: none"> Is temperature set to [High]? Is the room temperature too low? Is food with moisture stored close to the cold air spout? <p>Action</p> <ol style="list-style-type: none"> Set the temperature to [Middle] or [Low]. Food can be frozen if ambient temperature is below 5°C. Move to a place where the temperature is over 5°C. Place food with moisture on the shelves close to the doors.
Strange sounds from the refrigerator.	<p>Checkup Point</p> <ol style="list-style-type: none"> Is the floor beneath the refrigerator uneven? Is the space between refrigerator back and the wall too close? Do any objects or other stuff touch the refrigerator? <p>Action</p> <ol style="list-style-type: none"> Move the refrigerator to a level and even floor. Keep sufficient space. Remove any object which touches the refrigerator.
Odour or unpleasant smell from the inside.	<p>Checkup Point</p> <ol style="list-style-type: none"> Is the food stored uncovered or unwrapped? Are the shelves and pockets stained with food stuff? Is the food stored too long? <p>Action</p> <ol style="list-style-type: none"> Be sure to cover and wrap the food. Clean them regularly. Once smell gets soaked into those parts, it is not easy to remove. Do not store food for too long. A refrigerator is neither a perfect nor a permanent food keeper.

TROUBLE SHOOTING

PROBLEM	SOLUTION
Heat Front and side of refrigerator feels warm or hot.	Pipes (refrigerant vessel) are placed beneath the surface to prevent moisture forming on it.
Door is sticky Doors do not open easily.	When you close the door and then open again immediately, the door is not easy to open because warm air rushes in and creates the pressure difference. In this case wait for a minute, then it will open easily.
Strange sound It sounds like water is flowing from the refrigerator.	When the compressor starts to run or stop, refrigerant which makes the inside cold flowing in the pipes can make such a sound. Defrosted water can also make such a sound. (This refrigerator adopts an automatic defrosting system.)
Strange sound Cracking or clicking sounds.	Inside parts shrink and/or expand due to temperature change – When the inside gets cold or when the door is open, such sounds can be made.
Strange sound Humming or buzzing sounds.	Compressor or fans for cold air circulation can make such working sound. (If the refrigerator is not level, the sound can be louder.)
Frost and dew Dew or frost on the wall and/or food container surface in the freezer and refrigerator compartment.	Frost and/or dew can be made in the following cases; <ul style="list-style-type: none"> • High temperature and/or high humidity around the refrigerator. • When doors are open too long. • Food with much moisture are stored uncovered or unwrapped. <ul style="list-style-type: none"> – You can see the same appearance when cold water is poured in a glass cup and dew is forming on the surface of it.
Frost and dew Dew on the cabinet surface.	If it is highly humid around the refrigerator, moisture in the air sticks to the surface to form dew.
Ice & water not working	The ice and water dispenser does not operate if the right hand french door is opened.

Check if the refrigerator can pass a doorway or enter a door first. Dimensions (including Door Handles)
(Width*Depth*Height)
91.44cm x 92.20cm x 177.29cm

Find a suitable place to install
– Sufficient space from refrigerator back to the wall for free
– air ventilation.

Avoid direct sunlight.

*NOTE: Once the installation place is ready, follow the installation instructions.
If the surrounding temperature of refrigerator is low (below 5°C), food can be frozen or the refrigerator can work in abnormal way.*

IF THE REFRIGERATOR CAN NOT PASS THROUGH A DOOR DURING INSTALLATION, FOLLOW THESE STEPS.

This instruction manual refers to several models. The real features are model dependent.

REMOVING LEFT REFRIGERATOR DOOR

1. Unscrew top hinge cover with a screw driver and remove the hinge cover.

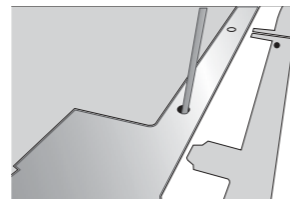

2. Unscrew the earth and disconnect the harness wires and water tube.

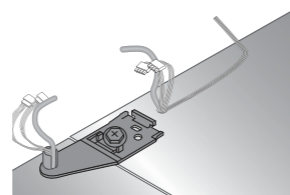

3. Turn top hinge fastener counterclockwise and remove the top hinge. (After the hinge is removed, the door can fall down forward. Be careful!!)

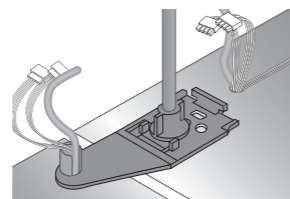

CAUTION

Risk of electric shock! Before removing top hinge cover:

- Shut off the water supply to the appliance.
- Unplug the appliance or switch off the fuse.

REMOVING RIGHT REFRIGERATOR DOOR

1. Turn top hinge fastener clockwise and remove the top hinge. (After the hinge is removed the door can fall down forward. Be careful!!)
2. Lift up the door and remove it. (The same as step 4, step 5 in the removing the left refrigerator door).

INSTALLATION PREPARATION

REMOVING FREEZER DOOR

1. Open freezer door as far as possible, pull up freezer case and freezer drawer.

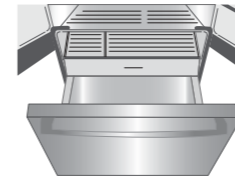

2. Push locks (on both sides) and pull forward Freezer door and remove.

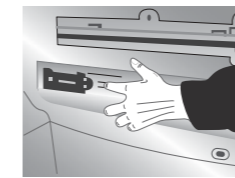

3. Bottom hinges may be required to be removed as well to get through some door openings.

REPLACING THE LEFT REFRIGERATOR DOOR

1. Replace the door to position.
2. Replace the top hinge and turn the top hinge fastener clockwise to tighten.
3. Screw in the earth and connect the harness wires and water tube.
4. Replace the hinge cover and screw in the top hinge cover with a screw driver.

REPLACING THE RIGHT REFRIGERATOR DOOR

1. Replace the door to position.
2. Replace the top hinge and turn the top hinge fastener clockwise to tighten.
3. Replace the hinge cover and screw in the top hinge cover with a screw driver.

CAUTION

Reconnection of all electrical plugs and the earth must be carried out by suitably qualified personnel

REFRIGERATOR LEVELING & DOOR ADJUSTMENT (IF NEEDED.)

The refrigerator must be level in order to maintain optimal performance and desirable front appearance. (If the floor beneath the refrigerator is uneven, The freezer and refrigerator doors look unbalanced.)

LEVELING AND DOOR ADJUSTMENT

Leveling the appliance

1. Remove the front cover, if it is attached.

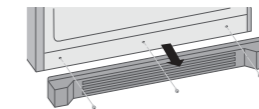

2. Use a hexagonal wrench to align the front of the appliance.

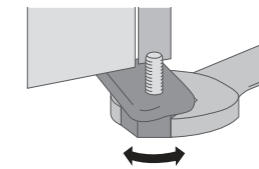

ADJUSTING A REFRIGERATOR DOOR

If the height of the refrigerator doors is uneven, turn the screw nut on the lower hinge to adjust the refrigerator door.

- To raise a refrigerator door turn the screw counterclockwise.

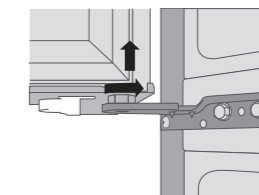

- To lower a refrigerator door turn the screw clockwise.

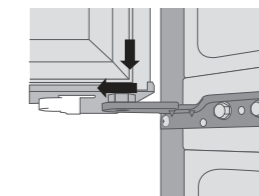

ALIGNING THE REFRIGERATOR DOORS

If the refrigerator doors are not properly aligned:

1. Unscrew the top hinge cover and raise the panel. Do not disconnect any harness wire or water tube!

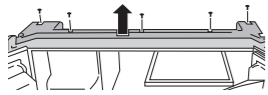

2. Loosen the fastener counterclockwise, move the hinge sideways to adjust the refrigerator door. Do not remove the fastener!

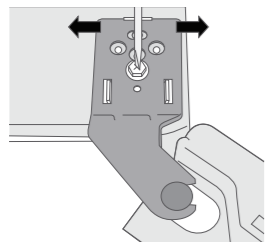

3. Tighten the fastener and replace the top hinge cover.

ADJUSTING THE FREEZER DRAWER

If the freezer drawer is not even:

1. Loosen the two side fasteners. Do not remove the fasteners!
2. Use the top fastener to adjust the freezer drawer.
3. If level of freezer drawer is proper, tighten the two side fasteners.

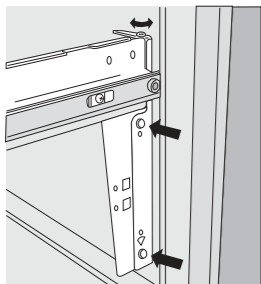

FRONT COVER

After installation and/or door leveling, fasten front cover with screws. (Remove the screws on the front bottom panel first. Click and screw the cover).

CAUTION

The front of refrigerator needs to be just a little higher than the back for easy door closing, but if the wheel is raised too much for door balance, i.e. the front of refrigerator is much higher than the back, it can be difficult to open the door.

INSTALLING THE HANDLES

1. Remove the handles from the packaging
2. Fit the refrigerator door first (A) by aligning the handle with the mounting locations on the door. (as shown below) ensuring that the handle end marked "TOP" is aligned with the top mounting location on the door.
3. Pull the handle down until you hear a "click"
4. Repeat this with the other refrigerator handle.

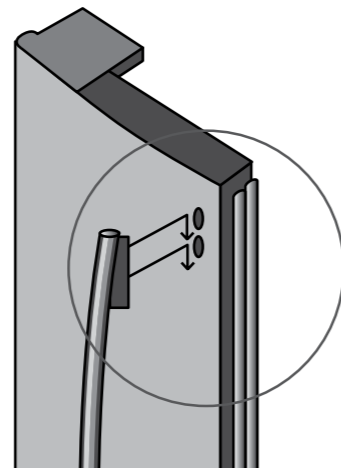

A (refrigerator handles)

5. Next, fit the freezer handle (B). (model WHE5100SA only)

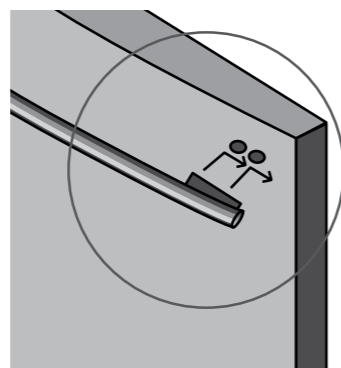

B (freezer handle)

6. Align the freezer handle with the mounting location on the freezer door, ensuring that the end marked "Right" is aligned with the mounting location on the right side of the door.
7. Pull the handle to the left until you hear a "click"
8. Clean your refrigerator thoroughly following the instructions on page 15 and wipe off any dust that has accumulated during shipping.
9. Plug your refrigerator straight into its own power point and never use a double adapter.
10. Before you put any food in your refrigerator, it is recommended you leave it on for 2 or 3 hours to check it is running properly and the appropriate temperature is reached.

FOLDAWAY DOOR BAR (MULLION BAR)

- When closing the left refrigerator door, the mullion bar folds behind the right refrigerator door, forming a seal between the refrigerator doors.
- When opening the left refrigerator door, the mullion bar folds back to the left door automatically.

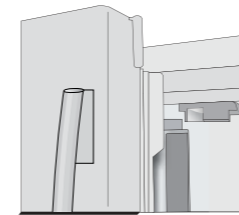

(mullion bar folds back O)

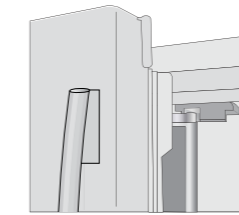

(mullion bar folds away X)

- The mullion bar may be damaged if you attempt to close the left refrigerator door with mullion bar fold away. When closing the left refrigerator door, make sure the mullion bar is folded back.

WATER FILTER

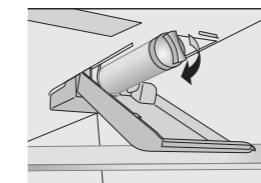
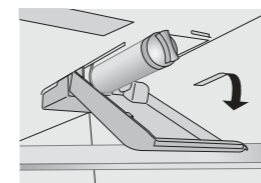

1. Disconnect the water supply to the appliance.
2. Remove the locking cap for installing the filter. (The ice and water dispenser can also be used without a water filter, in which case the locking cap must be used.)
3. Carefully turn the filter clockwise.
4. Change the filter at least every 6 months.

A New filter can be obtained from aftersales service. Contact :

Australia Please call 13 13 50

New Zealand Free call 0800 10 66 20

CAUTION

Wipe up with cloth if droplets fall when exchanging a filter. Draw water from the water dispenser for 5 minutes before use. This will remove air from the water system. margarine and cheeses. The compartment is slightly warmer than the rest of the refrigerator compartment, while the lid provides protection against odours.

INFORMATION CONCERNING THE WATER FILTER

- After use, the water system is subject to low pressure. Proceed with caution when removing the filter.
- Flush the water system if the appliance has not been in use for a lengthy period, or if the ice/water has an unpleasant taste or smell. To do this, dispense water through the water dispenser for several minutes. If the unpleasant taste or smell remains, replace the filter.
- Protect from frost, remove the filter cartridge if you expect the room temperature to drop below freezing.
- If pressure surges could occur in the water pipe, do not install the water filter without a suitable surge eliminator. Contact an installation expert if you are not sure whether pressure surges could occur in the water pipe.
- After installing a new filter: Discard any ice produced in the first 24 hours after switching on.
- If no ice has been removed for a lengthy period: Empty the ice box and discard any ice produced over the next 24 hours.

HOW TO INSTALL WATER LINE

1. The water pressure should be 29psi - 125psi or more to run the automatic icemaker. Check up your tap water pressure; if a cup of 180cc is full within 10 seconds, the pressure is OK.
2. When installing the water tubes, ensure they are not close to any hot surfaces.
3. The water filter only filters water; it does not eliminate any bacteria or microbes.
4. If the water pressure is not so high to run the icemaker, call the local plumber to get an additional water pressure pump.
5. If the water pressure exceeds 125psi a pressure reducing valve must be installed.
6. The filter life depends on the amount of use. We recommend you replace the filter at least once every 6 months.
7. After installation of refrigerator and water line system, select [WATER] on your control panel and press it for 2~3 minutes to supply water into the water tank and dispense water.
8. Use sealing tape to every connection of pipes/tubes to ensure there is no water leak.
9. The water tube should be connected to the cold water line.

Electrolux Warranty

FOR SALES IN AUSTRALIA AND NEW ZEALAND
APPLIANCE: REFRIGERATION

This document sets out the terms and conditions of the product warranties for Electrolux Appliances. It is an important document. Please keep it with your proof of purchase documents in a safe place for future reference should you require service for your Appliance.

WATER SUPPLY KIT

Check the parts below for installing water supply. Necessary parts are available at local service agents.

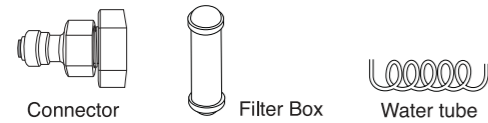

INSTALLATION PROCEDURE

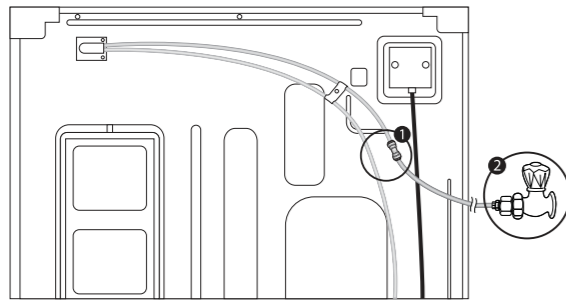

1. Connecting the appliance

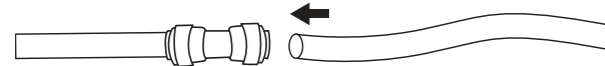

2. Connecting the tap water line

Figure A

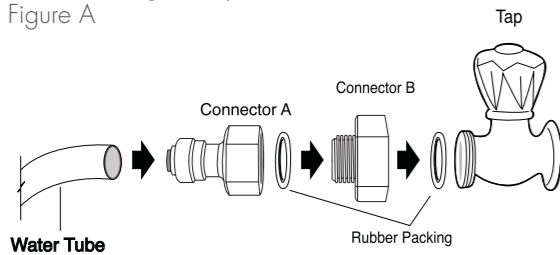
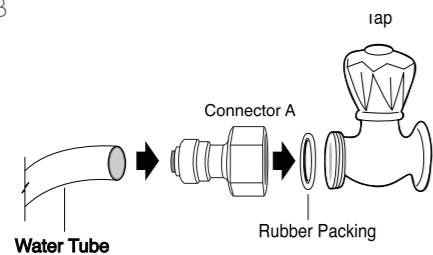

Figure B



Place the rubber washer inside the tap connector and screw onto the water tap.

Electrolux authorised representative, the Appliance is transported at the owner's cost and risk while in transit to and from Electrolux or its ASC.

6. Proof of purchase is required before you can make a claim under this warranty.
 7. You may not make a claim under this warranty unless the defect claimed is due to faulty or defective parts or workmanship. Electrolux is not liable in the following situations (which are not exhaustive):
 - (a) the Appliance is damaged by:
 - (i) accident
 - (ii) misuse or abuse, including failure to properly maintain or service
 - (iii) normal wear and tear
 - (iv) power surges, electrical storm damage or incorrect power supply
 - (v) incomplete or improper installation
 - (vi) incorrect, improper or inappropriate operation
 - (vii) insect or vermin infestation
 - (viii) failure to comply with any additional instructions supplied with the Appliance;
 - (b) the Appliance is modified without authority from Electrolux in writing;
 - (c) the Appliance's serial number or warranty seal has been removed or defaced;
 - (d) the Appliance was serviced or repaired by anyone other than Electrolux, an authorised repairer or ASC.
 8. This warranty, the contract to which it relates and the relationship between you and Electrolux are governed by the law applicable where the Appliance was purchased. Where the Appliance was purchased in New Zealand for business purposes the Consumer Guarantee Act does not apply.
 9. To the extent permitted by law, Electrolux excludes all warranties and liabilities (other than as contained in this document) including liability for any loss or damage whether direct or indirect arising from your purchase, use or non use of the Appliance.
 10. For Appliances and services provided by Electrolux in Australia, the Appliances come with a guarantee by Electrolux that cannot be excluded under the Australian Consumer Law. You are entitled to a replacement or refund for a major failure and for compensation for any other reasonably foreseeable loss or damage. You are also entitled to have the Appliance repaired or replaced if the Appliance fails to be of acceptable quality and the failure does not amount to a major failure. The benefits to you given by this warranty are in addition to your other rights and remedies under a law in relation to the Appliances or services to which the warranty relates.
 11. At all times during the Warranty Period, Electrolux shall, at its discretion, determine whether repair, replacement or refund will apply if an Appliance has a valid warranty claim applicable to it.
 12. For Appliances and services provided by Electrolux in New Zealand, the Appliances come with a guarantee by Electrolux pursuant to the provisions of the Consumer Guarantees Act, the Sale of Goods Act and the Fair Trading Act.
 13. To enquire about claiming under this warranty, please follow these steps:
 - (a) carefully check the operating instructions, user manual and the terms of this warranty;
 - (b) have the model and serial number of the Appliance available;
 - (c) have the proof of purchase (eg an invoice) available;
 - (d) telephone the numbers shown below.
 14. You accept that if you make a warranty claim, Electrolux and its ASC may exchange information in relation to you to enable Electrolux to meet its obligations under this warranty.
1. In this warranty
 - (a) 'acceptable quality' as referred to in clause 10 of this warranty has the same meaning referred to in the ACL;
 - (b) 'ACL' means Trade Practices Amendment (Australian Consumer Law) Act (No.2) 2010;
 - (c) 'Appliance' means any Electrolux product purchased by you accompanied by this document;
 - (d) 'ASC' means Electrolux' authorised serviced centres;
 - (e) 'Electrolux' means Electrolux Home Products Pty Ltd of 163 O'Riordan Street, Mascot, NSW 2020, ABN 51 004 762 341 in respect of Appliances purchased in Australia and Electrolux (NZ) Limited of 3-5 Niall Burgess Road, Mount Wellington, in respect of Appliances purchased in New Zealand;
 - (f) 'major failure' as referred to in clause 10 of this warranty has the same meaning referred to in the ACL and includes a situation when an Appliance cannot be repaired or it is uneconomic for Electrolux, at its discretion, to repair an Appliance during the Warranty Period;
 - (g) 'Warranty Period' means:
 - (i) where the Appliance is used for personal, domestic or household use (i.e. normal single family use) as set out in the instruction manual, the Appliance is warranted against manufacturing defects in Australia and New Zealand for 24 months and for the Appliance's compressor, condenser, evaporator and drier, an additional 36 months parts only warranty applies, following the date of original purchase of the Appliance;
 - (ii) where the Appliance is used for commercial purposes (including being used to directly assist a business or where the Appliance is used in a multi-family communal or share type environment), the Appliance will then be warranted against manufacturing defects in Australia for 3 months and in New Zealand for 3 months, following the date of original purchase of the Appliance.
 - (h) 'you' means the purchaser of the Appliance not having purchased the Appliance for re-sale, and 'your' has a corresponding meaning.
 2. This warranty only applies to Appliances purchased and used in Australia or New Zealand and is in addition to (and does not exclude, restrict, or modify in any way) any non-excludable statutory warranties in Australia or New Zealand.
 3. During the Warranty Period Electrolux or its ASC will, at no extra charge if your Appliance is readily accessible for service, without special equipment and subject to these terms and conditions, repair or replace any parts which it considers to be defective. Electrolux or its ASC may use remanufactured parts to repair your Appliance. You agree that any replaced Appliances or parts become the property of Electrolux. This warranty does not apply to light globes, batteries, filters or similar perishable parts.
 4. Parts and Appliances not supplied by Electrolux are not covered by this warranty.
 5. You will bear the cost of transportation, travel and delivery of the Appliance to and from Electrolux or its ASC. If you reside outside of the service area, you will bear the cost of:
 - (a) travel of an authorised representative;
 - (b) transportation and delivery of the Appliance to and from Electrolux or its ASC,
 In all instances, unless the Appliance is transported by Electrolux or an

Important Notice

Before calling for service, please ensure that the steps listed in point 13 above have been followed.

<p>FOR SERVICE or to find the address of your nearest state service centre in Australia PLEASE CALL 13 13 49 <small>For the cost of a local call (Australia only)</small></p>	<p>SERVICE AUSTRALIA Electrolux ELECTROLUX HOME PRODUCTS www.electrolux.com.au</p>	<p>FOR SPARE PARTS or to find the address of your nearest state spare parts centre in Australia PLEASE CALL 13 13 50 <small>For the cost of a local call (Australia only)</small></p>
<p>FOR SERVICE or to find the address of your nearest authorised service centre in New Zealand FREE CALL 0800 10 66 10 <small>(New Zealand only)</small></p>	<p>SERVICE NEW ZEALAND Electrolux ELECTROLUX HOME PRODUCTS www.electrolux.co.nz</p>	<p>FOR SPARE PARTS or to find the address of your nearest state spare parts centre in New Zealand FREE CALL 0800 10 66 20 <small>(New Zealand only)</small></p>

For more information on all Westinghouse appliances,
or for dimension and installation information, call into your retailer,
phone or email our customer care team or visit our website:

AUSTRALIA

phone: 1300 363 640
fax: 1800 350 067
email: customercare@electrolux.com.au
web: www.westinghouse.com.au

NEW ZEALAND

phone: 09 573 2384
fax: 0800 363 600
email: customercare@electrolux.co.nz
web: www.westinghouse.co.nz

Westinghouse. We are part of the Electrolux family.
Share more of our thinking at www.electrolux.com.au



 **Electrolux**

TOP SERVICE

TOP SERVICE

Top Service encompasses the after sales service provided by The Electrolux Group to consumers including delivery, home service and spare parts.

©2013 Electrolux Home Products Pty Ltd. ABN 51 004 762 341
WMAN_LGFD_Jan13
Part number: 30100C0200

 **Westinghouse**
made for modern families