

Ceramic glass hob

PHR & PHP-284U -285S -285W -395U

Welcome to the world of Electrolux

Thank you for choosing a first class product from Electrolux, which hopefully will provide you with lots of pleasure in the future. The Electrolux ambition is to offer a wide variety of quality products that make your life more comfortable. You will find some examples on the cover in this manual. Please take a few minutes to study this manual so that you can take advantage of the benefits of your new machine. We promise that it will provide a superior User Experience delivering Ease-of-Mind. Good luck!

Contents

Safety instructions	5
Description of the Appliance	7
Operating the appliance	9
Tips on Cooking and Frying	12
Cleaning and Care	14
What to do if ...	16
Disposal	17
Technical Data	18
Installation Instructions	19
Assembly	21
Guarantee/Customer Service	27
Service	29

The following symbols are used in this user manual:



Important information concerning your personal safety and information on how to avoid damaging the appliance.



General information and tips



Environmental information



Safety instructions



Please comply with these instructions. If you do not, any damage resulting is not covered by the warranty.



This appliance conforms with the following EU Directives:

- 73/23/EEC dated 19.02.1973 Low Voltage Directive
- 89/336/EEC dated 03.05.1989 EMC Directive inclusive of Amending Directive 92/31/EEC
- 93/68/EEC dated 22.07.1993 CE Marking Directive

Correct use

- This appliance should be used only for normal domestic cooking and frying of food.
- The appliance must not be used as a work surface or as a storage surface.
- Additions or modifications to the appliance are not permitted.
- Do not place or store flammable liquids, highly inflammable materials or fusible objects (e.g. plastic film, plastic, aluminium) on or near the appliance.

Children's safety

- The cooking zones will become hot when you cook. Therefore, always keep small children away from the appliance.

- This appliance is not intended for use by persons (including children) with reduced physical, sensory or mental capabilities, or lack of experience and knowledge, unless they have been given supervision or instruction concerning use of the appliance by a person responsible for their safety.
- Children should be supervised to ensure that they do not play with the appliance.

General safety

- The appliance may only be installed and connected by trained, registered service engineers.
- Built-in appliances may only be used after they have built in to suitable built-in units and work surfaces that meet standards.
- In the event of faults with the appliance or damage to the glass ceramic (cracks, scratches or splits), the appliance must be switched off and disconnected from the electrical supply, to prevent the possibility of an electric shock.
- Repairs to the appliance must only be carried out by trained registered service engineers..carried out by trained registered service engineers..

Safety during use

- Remove stickers and film from the glass ceramic.
- Clean oil from control panel (only 285S) before use.
- There is the risk of burns from the appliance if used carelessly.
- Cables from electrical appliances must not touch the hot surfaces of the appliance or hot cookware.
- Overheated fats and oils can ignite very quickly. When cooking with fat or oil (e.g. Chips) do not leave the appliance unattended.
- Switch the cooking zones off after each use.

Safety when cleaning

- For cleaning, the appliance must be switched off and cooled down.
- For safety reasons, the cleaning of the appliance with steam jet or high-pressure cleaning equipment is not permitted.

How to avoid damage to the appliance

- The glass ceramic can be damaged by objects falling onto it.
- The edge of the glass ceramic can be damaged by being knocked by the cookware.
- Cookware made of cast iron, cast aluminium or with damaged bottoms can scratch the glass ceramic if pushed across the surface.
- Objects that melt and things that boil over can burn onto the glass ceramic and should be removed straightaway.
- To avoid damaging cookware and glass ceramics, do not allow saucepans or frying pans to boil dry.
- Do not use the cooking zones with empty cookware or without cookware.

Description of the Appliance

Cooking surface layout

284 U

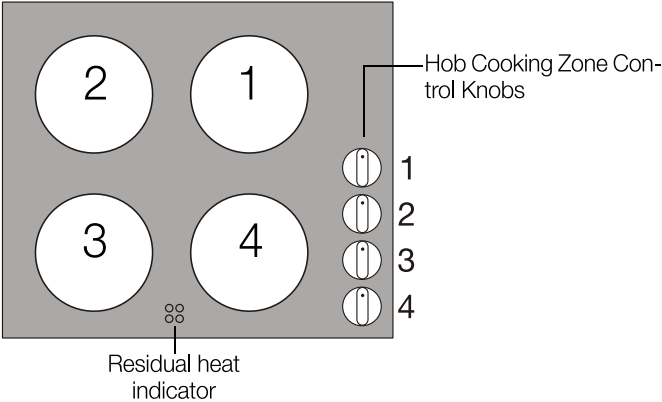

285 S / 285 W

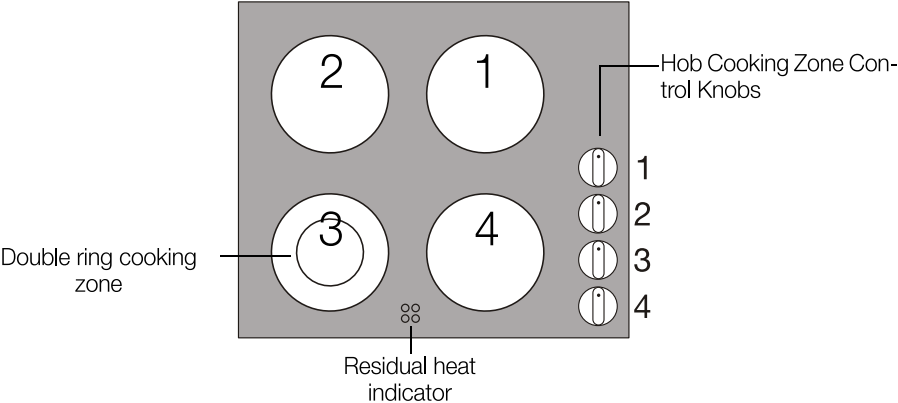

8 electrolux **description of the appliance**

395 U

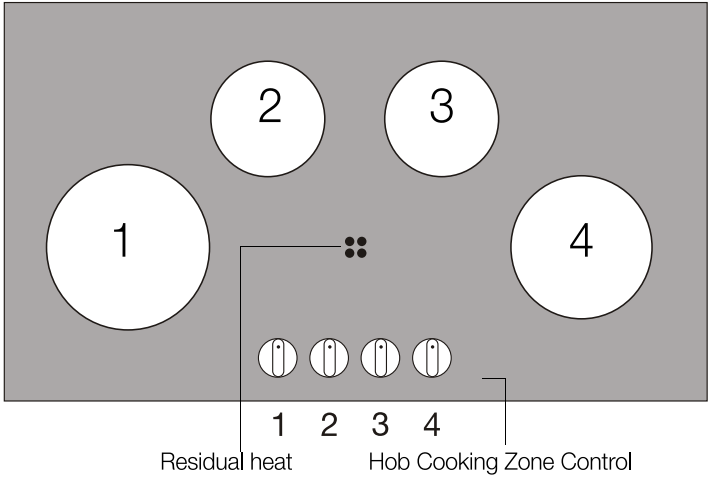

Residual heat indicator

The residual heat indicator lights up, as soon as the corresponding cooking zone is hot.



Danger! Risk of burns from residual heat. After being switched off, the cooking zones need some time to cool down. Look at the residual heat indicator.



Residual heat can be used for melting and keeping food warm.

Operating the appliance



When a cooking zone is switched on, it may hum briefly. This is a characteristic of all ceramic glass cooking zones and does not impair either the function or the life of the appliance.

Setting the heat setting

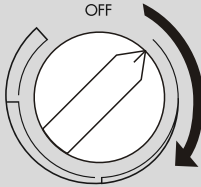
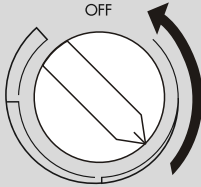
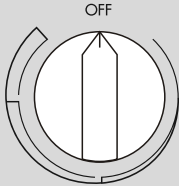
Heat setting	Ring control knob	Knob setting
To increase	turn clockwise	
To reduce	turn anti-clockwise	
switch off	turn to the Off position	

1. When boiling water/searing food, select a high heat setting.
2. As soon as steam forms or the fat or oil is hot, set a lower heat setting.
3. To end the cooking process, turn to the Off position.



The Ring-Control-Knobs for Single-Cooking-Zones can be turned either left or right.

285 S
285 W

To switch the outside ring on and off

By switching the outside ring on or off, the effective heating surface can be matched to the size of the cookware.

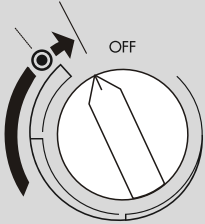
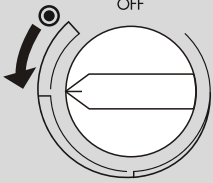
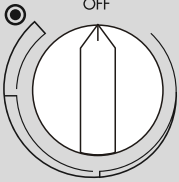

Before the outside ring can be switched on, the inside ring must be switched on.

Outside ring	Ring switch	Switch setting
To switch on	Turn clockwise, past a slight resistance, as far as it will go	
	Turn anti-clockwise to the desired heat setting	
To switch off	Turn to the Off position	

Tips on Cooking and Frying



Information on acrylamides

According to the latest scientific knowledge, intensive browning of food, especially in products containing starch, can constitute a health risk due to acrylamides. Therefore we recommend cooking at the lowest possible temperatures and not browning foods too much.

Cookware

- You can recognise good cookware from the bottoms of the pans. The bottom should be as thick and flat as possible.
- Cookware made of enamelled steel or with aluminium or copper bottoms can leave discolorations on the glass ceramic surface which are difficult or impossible to remove.

Energy saving



Always place cookware on the cooking zone before it is switched on.



If possible, always place lids on the pans.



Switch cooking zones off before the end of the cooking time, to take advantage of residual heat.



Bottom of pans and cooking zones should be the same size.

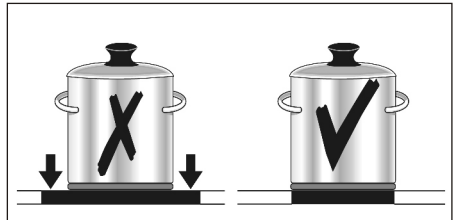
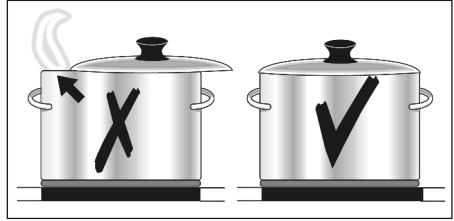

Cleaning and Care



Take care! Risk of burns from residual heat.



Warning! Sharp objects and abrasive cleaning materials will damage the appliance. Clean with water and washing up liquid.



Warning! Residues from cleaning agents will damage the appliance. Remove residues with water and washing up liquid.

Cleaning the appliance after each use

1. Wipe the appliance with a damp cloth and a little washing up liquid.
2. Rub the appliance dry using a clean cloth.

Removing deposits

1. Place a scraper on the glass ceramic surface at an angle.
2. Remove residues by sliding the blade over the surface.
3. Wipe the appliance with a damp cloth and a little washing up liquid.
4. Rub the appliance dry using a clean cloth.

Type of dirt	Remove		
	im- medi- ately	when the appliance has cooled down	using
sugar, food containing sugar	yes	---	a scraper*
plastics, tin foil	yes	---	
limescale and water rings	---	yes	cleaner for glass ce- ramic or stainless steel*
fat splashes	---	yes	
shiny metallic discolouration	---	yes	

*Scrapers and cleaners for glass ceramic and stainless steel can be purchased in specialist shops



Remove stubborn residues with a cleaner for glass ceramic or stainless steel.



Scratches or dark stains on the glass ceramic that cannot be removed do not however affect the functioning of the appliance.

What to do if ...

Problem	Possible cause	Remedy
The cooking zones are not functioning.	The desired heat setting is not set.	Set the heat setting.
	The fuse in the house's electrical wiring (fuse box) has been tripped.	Check the fuse. If the fuses trip a number of times, please call an authorised electrician.
The residual heat indicator is not displaying anything	The cooking zone was only on for a short time and is therefore not hot	If the cooking zone is supposed to be hot, call the Customer Service Department.

If you are unable to remedy the problem by following the above suggestions, please contact your dealer or the Customer Care Department.



Warning! Repairs to the appliance are only to be carried out by qualified service engineers. Considerable danger to the user may result from improper repairs.



If the appliance has been wrongly operated, the visit from the customer service technician or dealer may not take place free of charge, even during the warranty period.

Disposal



Packaging material

The packaging materials are environmentally friendly and can be recycled. The plastic components are identified by markings, e.g. >PE<, >PS<, etc. Please dispose of the packaging materials in the appropriate container at the community waste disposal facilities.



Old appliance

The symbol  on the product or on its packaging indicates that this product may not be treated as household waste. Instead it shall be handed over to the applicable collection point for the recycling of electrical and electronic equipment. By ensuring this product is disposed of correctly, you will help prevent potential negative consequences for the environment and human health, which could otherwise be caused by inappropriate waste handling of this product. For more detailed information about recycling of this product, please contact your local city office, your household waste disposal service or the shop where you purchased the product.

Technical Data

model	284 U		285 S		285 W		395 U	
PNC	949 163 085		949 163 083		949 163 086		949 163 089	
Product dimensions (w x d) mm	610 x 515		610 x 515		610 x 515		930 x 520	
Cut-out dimensions (w x d) mm	560 x 490 (485)		560 x 490 (485)		560 x 490 (485)		880 x 490 (485)	
Voltage (volts)	230		230		230		230	
Cycles (Hz)	50		50		50		50	
Service Cord	not fitted		not fitted		not fitted		not fitted	
elements	no. zones	watts	no. zones	watts	no. zones	watts	no-zones	watts
front left	1	2300	2	750/2200	2	750/2200	2	750/2200
rear left	1	1200	1	1200	1	1200	1	1200
front right	1	1200	1	1200	1	1200	1	1200
rear right	1	1800	1	1800	1	1800	1	1800
total		6500		6400		6400		6400

Installation Instructions

Safety instructions

The laws, ordinances, directives and standards in force in the country of use are to be followed (safety regulations, proper recycling in accordance with the regulations, etc.)

Installation may only be carried out by a qualified electrician.

The minimum distances to other appliances and units are to be observed.

Anti-shock protection must be provided by the installation, for example drawers may only be installed with a protective floor directly underneath the appliance. The cut surfaces of the worktop are to be protected against moisture using a suitable sealant.

The sealant seals the appliance to the work top with no gap.

Avoid installing the appliance next to doors and under windows. Otherwise hot cookware may be knocked off the rings when doors and windows are opened.



WARNING!

Risk of injury from electrical current.

- The electrical mains terminal is live.
- Make electrical mains terminal free of voltage.
- Observe connection schematic.
- Observe electrical safety rules.
- Ensure anti-shock protection through correct installation by a qualified electrician.
- The appliance must be connected to the electrical supply by a qualified electrician.



IMPORTANT!

Risk of injury from electrical current.

Loose and inappropriate plug and socket connections can make the terminal overheat.

- Have the clamping joints correctly installed by a qualified electrician.
- Use strain relief clamp on cable.
- CAUTION: The surface temperature exceeds 95°C. To avoid a hazard, underbench access must be restricted.
- Supply cords must have a temperature rating not less than 105°C.

Electrical Connection

Before connecting, check that the nominal voltage of the appliance, that is the voltage stated on the rating plate, corresponds to the available supply voltage. The rating plate is located on the lower casing of the hob.

The heating element voltage is AC230V~. The appliance also works perfectly on networks with AC220V~ or AC240V~.

The hob is to be connected to the mains using a device that allows the appliance to be disconnected from the mains at all poles with a contact opening width of at least 3 mm, eg. automatic line protecting cut-out, earth leakage trips or fuse.

A cable with minimum temperature rating of V90HT or one with a higher grade must be used as the mains connecting cable.

The connection must be carried out as shown in the diagram. The connecting links should be fitted according to the appropriate connection diagram. The earth lead is connected to terminal ⊕.

The earth lead must be longer than leads carrying electric current.

The cable connections must be made in accordance with regulations and the terminal screws tightened securely.

Finally, the connecting cable is to be secured with the mains cable cleat and the covering closed by pressing firmly (lock into place).

Before switching on for the first time, any protective foil or stickers must be removed from the glass ceramic surface.



Once connected to the mains supply check that all cooking zones are ready for use by briefly switching each on in turn at the maximum setting.

Sticking on the seal

- Clean the worktop around the cut-out area.
- Stick the single-sided adhesive sealing tape provided on the underside of the hob around the outside edge ensuring that it is not stretched. The two ends of the tape should join in the middle of one side. After trimming the tape (allow it to overlap by 2-3 mm), press the two ends together.



The cut-out section in the worktop is illustrated in the drawing with the dimensions 560 x 490 / 880 x 490 mm. The appliance can also be built into a shorter cut-out section with the dimensions 560 x 485 / 880 x 485 mm.

Assembly

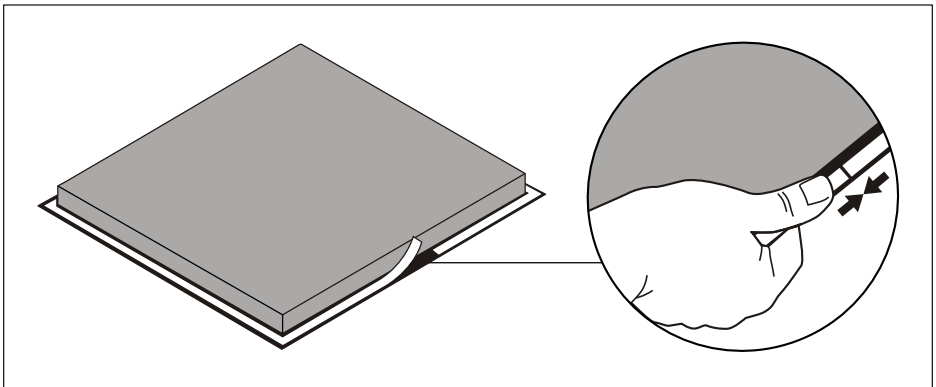
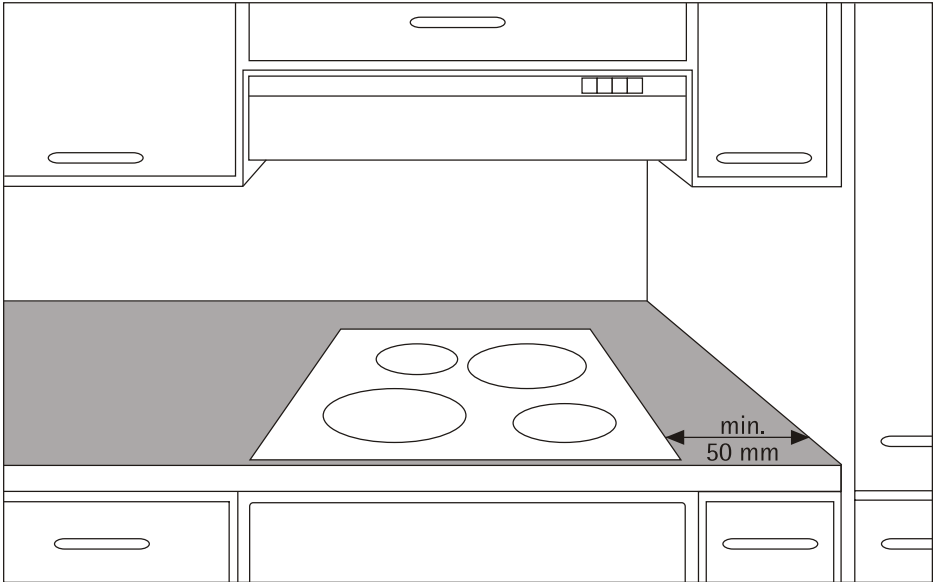

22 electrolux assembly

284 U / 285 S / 285 W

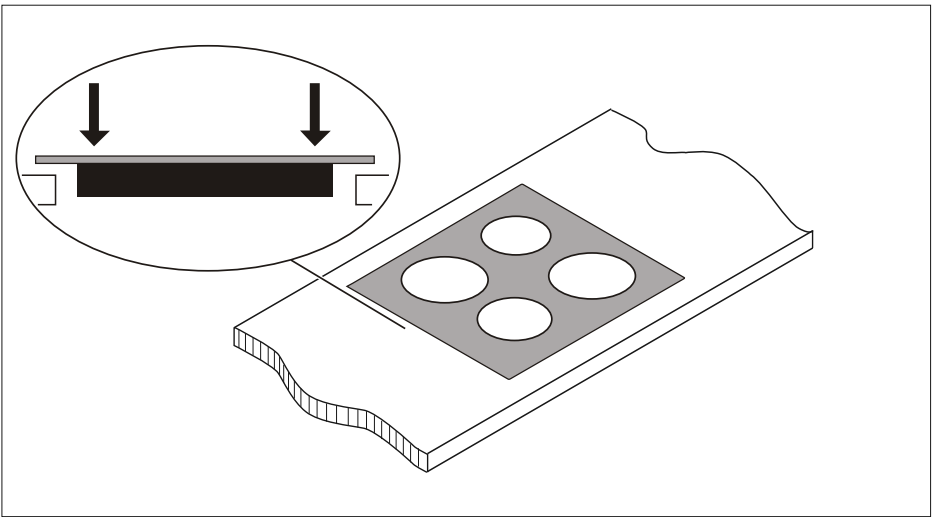
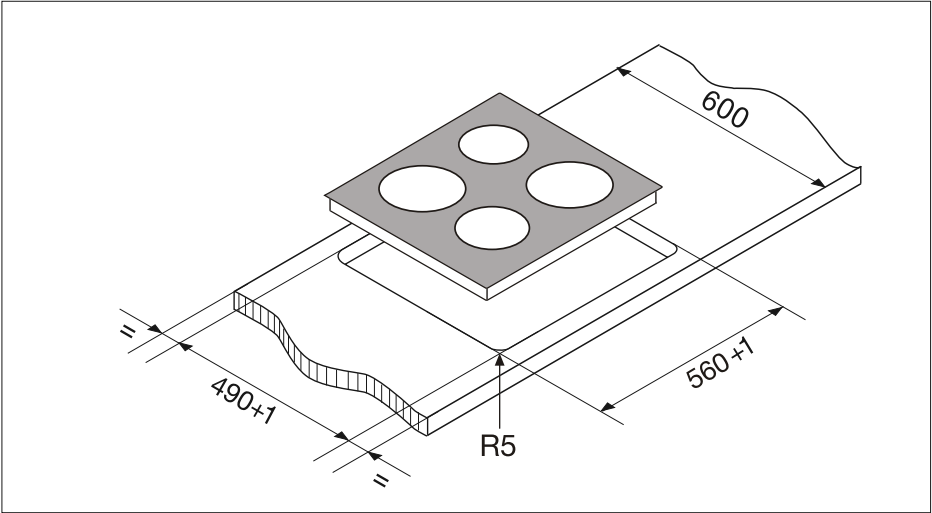

395 U

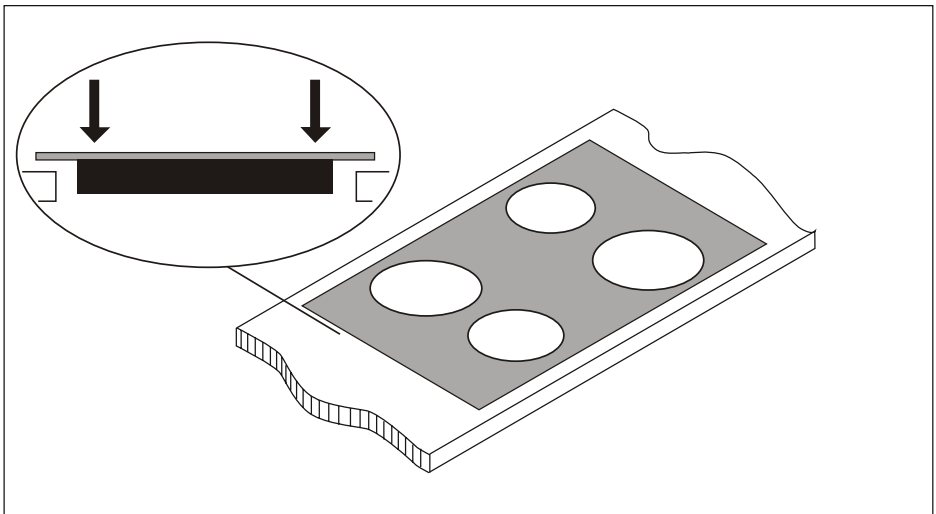
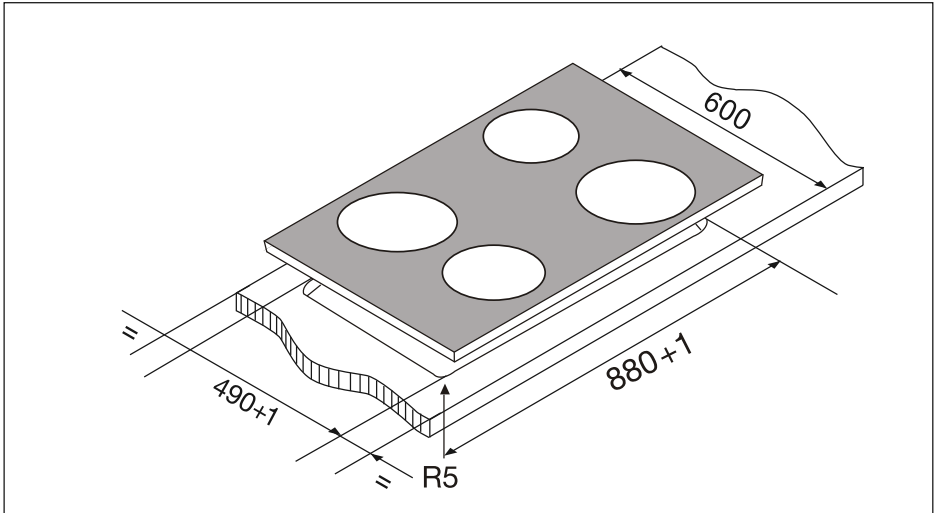

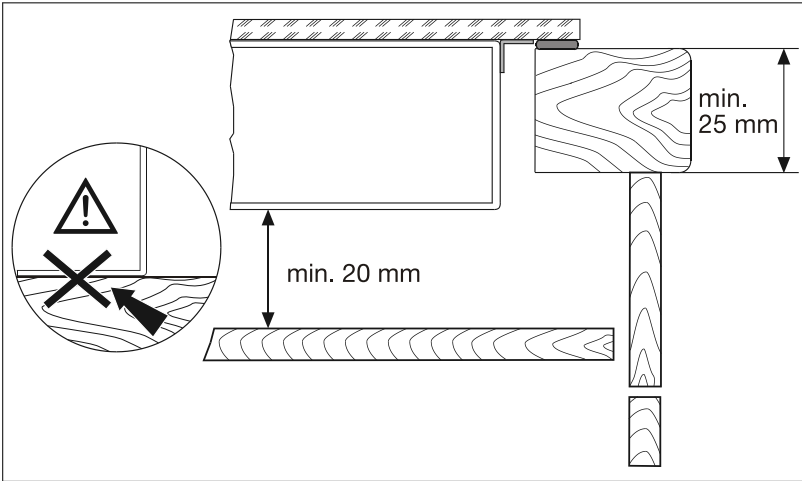

INSTALLATION ABOVE CUPBOARDS OR DRAWERS

Under hob access must be restricted by the addition of a board mounted at least 20mm from Underside of hob.

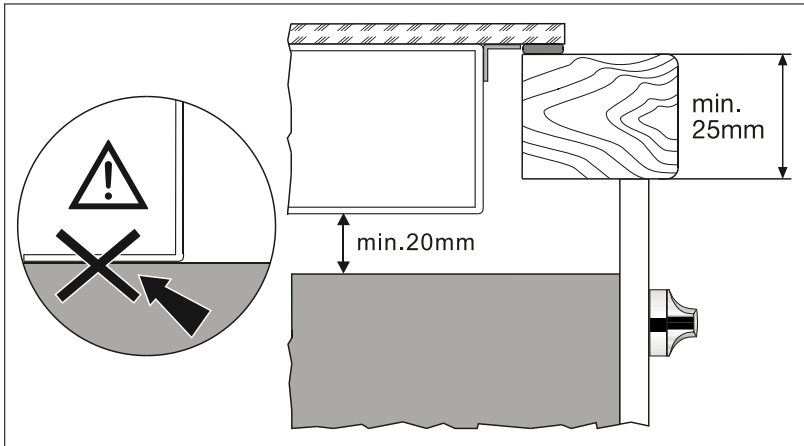





INSTALLATION ABOVE CUPBOARDS OR DRAWERS





Under hob access must be mounted at least 20mm from top of appliance.

Rating Plates





Electrolux PNC: 949163085
 Made in China Model: PHP284U
 APP NO.: PEE2 100
 AU APP NO.: S/91
 S NO: 50Hz 6,5

  
 220 - 240 VAC
 220 - 240 V
 5022
 KW





Electrolux PNC: 949163083
 Made in China Model: PHP285S
 APP NO.: PEE2 100
 AU APP NO.: S/91
 S NO: 50Hz 6,4

  
 220 - 240 VAC
 220 - 240 V
 5022
 KW

Electrolux PNC: 949163086
 Made in China Model: PHP285W
 APP NO.: PEE2 100
 AU APP NO.: S/91
 S NO: 50Hz 6,4





  
 220 - 240 VAC
 220 - 240 V
 5022
 KW

Electrolux PNC: 949163089
 Made in China Model: PHP395U
 APP NO.: PEE2 101
 AU APP NO.: S/91
 S NO: 50Hz 6,4



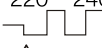

  
 220 - 240 VAC
 220 - 240 V
 5022
 KW

Rating Plates



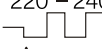

Electrolux PNC: 949163183
 Made in China Model: PHR284U
 APP NO.: PEE2 100
 AU APP NO.: S/91
 S NO: 50Hz 6,5

 KW   220 - 240 V AC
 220 - 240 V
 5022





Electrolux PNC: 949163184
 Made in China Model: PHR285W
 APP NO.: PEE2 100
 AU APP NO.: S/91
 S NO: 50Hz 6,4

 KW   220 - 240 V AC
 220 - 240 V
 5022

Electrolux PNC: 949163185
 Made in China Model: PHR285S
 APP NO.: PEE2 100
 AU APP NO.: S/91
 S NO: 50Hz 6,4

 KW   220 - 240 V AC
 220 - 240 V
 5022

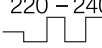
Electrolux PNC: 949163186
 Made in China Model: PHR395U
 APP NO.: PEE2 101
 AU APP NO.: S/91
 S NO: 50Hz 6,4

 KW   220 - 240 V AC
 220 - 240 V
 5022

Guarantee/Customer Service

Electrolux Warranty

FOR SALES IN AUSTRALIA AND NEW ZEALAND
APPLIANCE: BUILT-IN OVEN COOKTOP
AND FREESTANDING COOKER

This document sets out the terms and conditions of the product warranties for Electrolux Appliances. It is an important document.

Please keep it with your proof of purchase documents in a safe place for future reference should you require service for your Appliance.

1. In this warranty
 - (a) 'acceptable quality' as referred to in clause 10 of this warranty has the same meaning referred to in the ACL;
 - (b) 'ACL' means Trade Practices Amendment (Australian Consumer Law) Act (No.2) 2010;
 - (c) 'Appliance' means any Electrolux product purchased by you accompanied by this document;
 - (d) 'ASC' means Electrolux' authorised serviced centres;
 - (e) 'Electrolux' means Electrolux Home Products Pty Ltd of 163 O'Riordan Street, Mascot, NSW 2020, ABN 51 004 762 341 in respect of Appliances purchased in Australia and Electrolux (NZ) Limited of 3-5 Niall Burgess Road, Mount Wellington, in respect of Appliances purchased in New Zealand;
 - (f) 'major failure' as referred to in clause 10 of this warranty has the same meaning referred to in the ACL and includes a situation when an Appliance cannot be repaired or it is uneconomic for Electrolux, at its discretion, to repair an Appliance during the Warranty Period;
 - (g) 'Warranty Period' means:
 - (i) where the Appliance is used for personal, domestic or household use (i.e. normal single family use) as set out in the instruction manual, the Appliance is warranted against manufacturing defects in Australia for 24 months and in New Zealand for 24 months, following the date of original purchase of the Appliance;
 - (ii) where the Appliance is used for commercial purposes (including being used to directly assist a business or where the Appliance is used in a multi-family communal or share type environment), the Appliance will then be warranted against manufacturing defects in Australia for 3 months and in New Zealand for 3

months, following the date of original purchase of the Appliance.

- (h) 'you' means the purchaser of the Appliance not having purchased the Appliance for re-sale, and 'your' has a corresponding meaning.
2. This warranty only applies to Appliances purchased and used in Australia or New Zealand and is in addition to (and does not exclude, restrict, or modify in any way) any non-excludable statutory warranties in Australia or New Zealand.
3. During the Warranty Period Electrolux or its ASC will, at no extra charge if your Appliance is readily accessible for service, without special equipment and subject to these terms and conditions, repair or replace any parts which it considers to be defective. Electrolux or its ASC may use remanufactured parts to repair your Appliance. You agree that any replaced Appliances or parts become the property of Electrolux. This warranty does not apply to light globes, batteries, filters or similar perishable parts.
4. Parts and Appliances not supplied by Electrolux are not covered by this warranty.
5. You will bear the cost of transportation, travel and delivery of the Appliance to and from Electrolux or its ASC. If you reside outside of the service area, you will bear the cost of:
 - (a) travel of an authorised representative;
 - (b) transportation and delivery of the Appliance to and from Electrolux or its ASC,In all instances, unless the Appliance is transported by Electrolux or an Electrolux authorised representative, the Appliance is transported at the owner's cost and risk while in transit to and from Electrolux or its ASC.
6. Proof of purchase is required before you can make a claim under this warranty.
7. You may not make a claim under this warranty unless the defect claimed is due to faulty or defective parts or workmanship. Electrolux is not liable in the following situations (which are not exhaustive):
 - (a) the Appliance is damaged by:
 - (i) accident
 - (ii) misuse or abuse, including failure to properly maintain or service
 - (iii) normal wear and tear
 - (iv) power surges, electrical storm damage or incorrect power supply

- (v) incomplete or improper installation
 - (vi) incorrect, improper or inappropriate operation
 - (vii) insect or vermin infestation
 - (viii) failure to comply with any additional instructions supplied with the Appliance;
 - (b) the Appliance is modified without authority from Electrolux in writing;
 - (c) the Appliance's serial number or warranty seal has been removed or defaced;
 - (d) the Appliance was serviced or repaired by anyone other than Electrolux, an authorised repairer or ASC.
8. This warranty, the contract to which it relates and the relationship between you and Electrolux are governed by the law applicable where the Appliance was purchased. Where the Appliance was purchased in New Zealand for business purposes the Consumer Guarantee Act does not apply.
9. To the extent permitted by law, Electrolux excludes all warranties and liabilities (other than as contained in this document) including liability for any loss or damage whether direct or indirect arising from your purchase, use or non use of the Appliance.
10. For Appliances and services provided by Electrolux in Australia, the Appliances come with a guarantee by Electrolux that cannot be excluded under the Australian Consumer Law. You are entitled to a replacement or refund for a major

failure and for compensation for any other reasonably foreseeable loss or damage. You are also entitled to have the Appliance repaired or replaced if the Appliance fails to be of acceptable quality and the failure does not amount to a major failure. The benefits to you given by this warranty are in addition to your other rights and remedies under a law in relation to the Appliances or services to which the warranty relates.

11. At all times during the Warranty Period, Electrolux shall, at its discretion, determine whether repair, replacement or refund will apply if an Appliance has a valid warranty claim applicable to it.
12. For Appliances and services provided by Electrolux in New Zealand, the Appliances come with a guarantee by Electrolux pursuant to the provisions of the Consumer Guarantees Act, the Sale of Goods Act and the Fair Trading Act.
13. To enquire about claiming under this warranty, please follow these steps:
- (a) carefully check the operating instructions, user manual and the terms of this warranty;
 - (b) have the model and serial number of the Appliance available;
 - (c) have the proof of purchase (eg an invoice) available;
 - (d) telephone the numbers shown below.
14. You accept that if you make a warranty claim, Electrolux and its ASC may exchange information in relation to you to enable Electrolux to meet its obligations under this warranty.

Important Notice

Before calling for service, please ensure that the steps listed in point 13 above have been followed.

<p>FOR SERVICE or to find the address of your nearest state service centre in Australia PLEASE CALL 13 13 49 For the cost of a local call (Australia only)</p>	<p>SERVICE AUSTRALIA  ELECTROLUX HOME PRODUCTS www.electrolux.com.au</p>	<p>FOR SPARE PARTS or to find the address of your nearest state spare parts centre in Australia PLEASE CALL 13 13 50 For the cost of a local call (Australia only)</p>
<p>FOR SERVICE or to find the address of your nearest authorised service centre in New Zealand FREE CALL 0800 10 66 10 (New Zealand only)</p>	<p>SERVICE NEW ZEALAND  ELECTROLUX HOME PRODUCTS www.electrolux.co.nz</p>	<p>FOR SPARE PARTS or to find the address of your nearest state spare parts centre in New Zealand FREE CALL 0800 10 66 20 (New Zealand only)</p>

Service

In the event of technical faults, please first check whether you can remedy the problem yourself with the help of the operating instructions (section “What to do if...”).

If you were not able to remedy the problem yourself, please contact the Customer Care Department or one of our service partners.

In order to be able to assist you quickly, we require the following information:

- Model description
- Product number (PNC)
- Serial number (S No.)
(for numbers see rating plate)
- Type of fault
- Any error messages displayed by the appliance
- three digit letter-number combination for glass ceramic

So that you have the necessary reference numbers from your appliance at hand, we recommend that you write them in here:

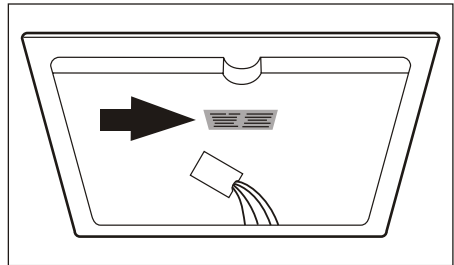

Model description:

PNC:

S No:

www.electrolux.com

www.westinghouse.com.au